

# Marley DWV

# Technical Design Manual.





# Introduction

---

This is the second edition of the Marley New Zealand Ltd DWV Installation and Technical Catalogue. It provides a practical guide to the design, installation and operation of unplasticised polyvinyl chloride (PVC) pipelines used for the conveyance of foul water.

Its revision has been prompted by the amalgamation of the New Zealand and Australian Standards, which has resulted in two key documents; AS/NZS 1260 PVC pipes and fittings for drain waste and vent, AS/NZS 3500.2.2 Sanitary plumbing and drainage - acceptable solutions Installation method.

Since the introduction of PVC Pipes into the New Zealand plumbing and drainage market over three decades ago, PVC DWV pipe has become an integral link in foul water drainage systems in this country.

PVC pipe has proven to be the most competitive in cost, with ease of installation combined with its physical characteristics of corrosion resistance and high strength to weight ratio, justifying its selection as the prime material option for drainage networks.

Over the last fifteen years extensive research and development has resulted in continual improvements in processing techniques, quality control and behavioural understanding of the material. Users of PVC pipes and fittings manufactured to AS/NZS 1260 are assured of consistently high quality products which, in addition to their traditional characteristics, now have enhanced toughness.

This second edition reflects the changes in specifications and materials which have taken place since the first edition was produced.

We trust you will find this design manual informative and a key point of reference in conducting any aspect of design, installation or sale.

# 1. PVC Pipe Properties

---

## MATERIAL PROPERTIES

### 1.1 Mechanical Properties of PVC @ 20°C

Density	1.42 - 1.48
Water Absorption	0.12% in 24 hours @ 23°
Hardness (Shore D)	80
Impact 20°C (Charpy 250µm notch)	20 KJ/m <sup>2</sup> (PVC)
Impact 0° (Charpy 250µm notch)	8 KJ/m <sup>2</sup> (PVC)
Coefficient of Friction (PVC to PVC)	0.4
Ultimate Tensile Strength	52 MPa
Elongation at Break	50 - 80%
Short Term Rupture	44 MPa
Long Term Creep	28 MPa
Compressive Strength	65 MPa
Long Term Creep Modulus	0.9 - 1.2 GPa
Elastic Tensile Modulus	3.0 - 3.3 GPa
Elastic Flexural Modulus	2.7 - 3.0 GPa
Shear Modulus	1.0 GPa
Bulk Modulus	4.7 GPa
Poisson Ratio	0.4

### 1.2 Electrical Properties

Dielectric Strength	14-20 KV/mm
Volume Resistivity	2 x 10 <sup>14</sup> Ω.m
Surface Resistivity	10 <sup>13</sup> - 10 <sup>14</sup> Ω
Dielectric Constant 50Hz (10 <sup>6</sup> Hz)	3.9 (3.3)
Power Factor 50Hz (10 <sup>6</sup> Hz)	0.01 (0.02)
Voltage Breakdown	2000 volts/mm
Insulating Strength	> 500 MΩ

### 1.3 Thermal Properties

Softening Point	79-84°C
Maximum Continuous Service Temp	60°C
Coefficient of Thermal Expansion	8 x 10 <sup>-5</sup>
Thermal Conductivity	0.16 W/[m.°C]
Specific Heat	1000 J/[Kg. °C]
Thermal Diffusivity	1.1 x 10 <sup>-7</sup> m <sup>2</sup> /S

### 1.4 Flammability Characteristics

Flammability (Oxygen Index)	45%
Ignitability Index	9 - 10 (/20)
Smoke Produced Index	4 - 6 (/10)
Heat Evolved Index	0
Spread of Flame Index	*

} AS 1530 Early Fire Hazard

\* PVC is self extinguishing. It does not support combustion when the source of ignition is removed.

# 1. PVC Pipe Properties

---

## PIPE PROPERTIES

### 1.5 Service Temperature

All Marley drains, wastes and vents are suitable for the continuous discharge of liquids at temperatures up to 60°C for vertical pipes and grade pipes, as well as intermittent discharges of liquids up to 90°C where the duration of the discharge does not exceed 90 seconds.

For discharge of liquids at temperatures above 60°C but not exceeding 75°C graded pipes and fittings must be continuously supported. PVC must not be used for continuous discharge of liquids at temperatures exceeding 75°C.

### 1.6 Durability

Marley DWV waste and vent pipes and fittings fully comply with G13/AS2 Table 3 and E1/AS1 Table 1.

PVC has proven durability over the last 50 years. The Marley system alone has been successfully used in New Zealand for 30 years. When installed and used in accordance with the installation instruction (see section four). Marley waste & vent pipes will have durability in excess of:

- 50 years for systems with difficult access (eg under buildings)
- 15 years for systems with a moderate ease of access, but difficult to replace (eg typical drainage system laid adjacent to a building foundation).

Marley DWV Sanitary drains will have a life expectancy in excess of 100 years, when installed, bedded and used in accordance with the installation and operation instructions.

### 1.7 Weatherability

All Marley DWV pipes and fittings have 1.5 PHR of Titanium Dioxide to provide long term UV protection when installed above ground. The ultimate strength of PVC does not alter markedly with age. With prolonged exposure to UV light, a loss of impact strength can be expected, although changes are minor and should not reduce the system's long-term performance.

For above ground systems, extra UV light protection can be added by simply applying a coat of 100% acrylic paint. Pipes should be washed with detergent and water to remove any grease and dirt. If priming is required, use an alkyd-based general purpose primer before the acrylic finishing coats.

### 1.8 Impact Strength

Impact tests of all DWV Pipe Systems are carried out to AS/NZS 1260 and AS/NZS 1462.3.

At low temperatures the impact strength of standard PVC will be reduced, therefore care needs to be taken when cutting, handling or backfilling in cold conditions.

### 1.9 Biological Attack

The performance of PVC pipe in severe environments has been studied since its introduction in the 1930s. These studies have found that PVC pipe will not deteriorate or break down under biological attack, as PVC does not serve as a nutrient for micro or macro organisms. Investigations have failed to discover a single case in which buried PVC pipe products have suffered degradation or deterioration due to biological attack.

Once PVC pipe has been installed underground in normal water and sewer systems, it is not susceptible to the normal processes of deterioration found in nature. It does not slime as readily as many other materials and will usually require less maintenance (blockage clearance).

# 1. PVC Pipe Properties

## 1.10 Abrasion

The abrasion resistance of solid wall PVC for main sewer lines has been shown to be superior to most other common piping materials.

Abrasion tests were performed by the Institute for Hydromechanics and Hydraulic Structures of the Technical University of Darmstadt, West Germany. Abrasion evaluation using river sand and gravel in unlined concrete pipe, lined concrete pipe, glazed vitrified clay pipe and PVC pipe produced the following results:

	MATERIAL	Cycle Comment
PVC (Solid Wall)	Minimal wear at	Less accelerated than 260,000 cycles vitrified clay
Concrete (unlined)	Measurable wear at	150,000 cycles
Concrete (lined)	Measurable wear at	Less wear than unlined 150,000 cycles concrete
Vitrified clay (glazed)	Minimal wear at 260,000 cycles	Accelerated wear after glazing wore off at 260,000 cycles

## 1.11 Electrolytic Properties

PVC is totally inert and therefore is non-conducting and non-magnetic, hence it will not be subject to electrolysis or corrosion when jointed to metal or other material.

PVC can **not** be used as an earth for electrical services.

## 1.12 Corrosion in Drains

Sanitary drains generate significant volumes of Hydrogen Sulphide gas from bacterial action, which results in the generation of dilute Sulphuric and sulphurous acids especially in turbulent areas.

Marley PVC has excellent resistance to Sulphuric Acid. See chemical resistance Section 11 for a more extensive list on chemical resistance.

## 1.13 Chemical Resistance of PVC

Marley PVC pipe has excellent resistance to a wide range of chemicals at ambient temperatures. Refer to section 11 for a comprehensive list.

*Factors Affecting Chemical Resistance:*

*Concentration:* In general, PVC is suitable to convey most strong acids, alkalies and aqueous solutions (except strongly oxidising solutions).

PVC should not be used with aldehydes, ethers, esters, aromatics, chlorinated hydrocarbons, ketones, benzene mixtures or similar solvents.

*Temperature:* As with all processes, the rate of attack will increase with temperature.

*Period of Contact:* In many instances the rate of attack is very slow and is only significant if exposure is prolonged, concentrate, or at elevated temperature.

If highly stressed, deterioration can involve absorption of the corroding medium, which leads to swelling, a reduction in tensile strength and a change in elongation at break.

*Joints:* Consideration must be given to the effects of any solution on solvent or rubber ring joints.

Unless otherwise requested, Marley PVC DWV pipes are fitted with blended natural rubber rings complying to AS 1646.

## 2. Product Data

### 2.1 Joint Systems

Rubber ring jointing (RRJ) and solvent socket jointing (SOE) are the standard systems provided. Rubber ring jointing is the preferred method for below ground installations.

Solvent welded joints are typically used in smaller diameter pipes, and are available in sizes up to and including DN175. Rubber Ring Joints (RRJ) are available in sizes 100DN and greater. See section 3.

### 2.2 Markings

All Marley DWV pipes are printed with the following details at approximately metre intervals.

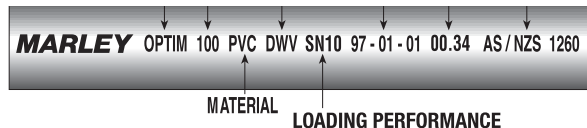

### 2.3 Types of Pipes

Marley currently manufactures three different types of pipe for drainage applications.

**2.3.1 Marley Optim** - This is a solid wall PVC pipe produced from selected materials to give an extra rigid durable pipe system.

**2.3.2 Marley Impact** - This solid wall mPVC is produced to provide extreme ductility in areas where the pipe could be subjected to adverse mechanical treatment.

Class SN20 is pressure rated to PN9 and may be used for pumping and rising sewer mains subject to normal design and installation requirements.

Other stiffness classes SN4, SN8 and SN16 are available in this product to suit specific installation requirements.

This pipe has excellent cold temperature performance.

**2.3.3 Marley Optim2000SC** - Is a composite sandwich wall from selected rigid PVC designed for ease of handling, but with excellent durability and wall thicknesses to give the same high performance as *Marley Optim*.

### 2.4 Classes Stiffness Performance Rating

Marley PVC DWV pipe system is manufactured to different pipe stiffness classes to suit the performance requirements of the installation. These are designated by the Nominal Stiffness (SN) in N/m/m as determined according to the crush resistance test of AS1462.22.

**SN4 and SN6** - These pipes are considered suitable for all domestic plumbing and drainage for domestic and residential housings in 100 and 150mm sizing.

**SN8 and SN10** - Is suitable for general drainage and commercial installation where higher pipe stiffness is required to provide minimum deflection of installed pipes, due to imposed loads from backfill or to assist with poor bedding practices and materials.

**SN16 and Greater-Territorial Authority** - This pipe is designed to meet the requirements of the Territorial Authority where very high long term stiffness is required to provide minimal ovality due to high imposed traffic loads or very high coverage depths and to accommodate varying bedding performance to give long term asset cost performance in excess of 100 years for territorial authority services.

## 2. Product Data

---

### 2.5 Production Quality Control and Quality Assurance

**2.5.1** The manufacture of PVC pipe involves continuous processing of the polymer, which necessitates the strict and accurate control of both materials and plant to meet the required standards. Marley has adopted individual internal procedures which embrace increasingly comprehensive testing by the process technician on each line and quick response laboratory testing programmes, with trained production personnel operating quality manufacturing systems.

**2.5.2** These quality control procedures normally include:

- Quality testing of raw materials.
- Checks on the uniformity and consistency of the powder blend input.
- Control of processing parameters in terms of temperature, pressure, flow rates, haul-off speed and energy input.
- Visual inspection of the pipes to check general appearance, dimensional compliance, including wall thickness, diameter, length, socket jointing ends and sealing rings.
- Production tests are carried out at regular intervals from each extrusion line, usually one sample every 2 hours. These laboratory tests are fully recorded and identify the pipe by time and date so they can be related to pipe in the field.

**2.5.3** Quality control tests and procedures are performed by trained personnel in accordance with ISO 9002 Quality Management System in our International Accreditation New Zealand Resistered Laboratory (Reg No 92).

- *Dimensional Measurement* of external diameter and pipe wall thickness (AS/NZS 1462.1).
- *Deformation Tests* to check the pipe stiffness (AS/NZS 1462.22)
- *Impact Tests* to check the general toughness of the pipe and its ability to withstand the normal shocks which may be expected during handling, transportation and installation during normal use. (AS/NZ 1462.3).
- *Heat Reversion Tests* designed to show up any excessive built-in (residual) stresses in the pipe and fittings (AS/NZ 1462.4) (AS/NZ 1462.11).
- *Production Type Tests*. In addition to “production monitoring” tests, there are a number of important longer term “Type Tests” which are required to demonstrate the pipes long term performance. These tests are reviewed at less frequent intervals and are carried out whenever there is any change in parameters such as formulation, size, classification and processing technique.

### 2.6 Standards

Marley’s PVC DWV range of pipe systems are manufactured to AS/NZS 1260 “PVC pipes and fittings for drain waste and vent applications”.

This manual is designed to assist in the use of the Marley DWV range of pipes and fittings in complying with Building Industry Code G13 and B2 and Installation and Design Practices AS/NZS 3500.2.2.individual back vents and minimising waste pipe and external gully traps.



### 3. Product Dimensions

**STANDARDS: AS/NZS 1260 : 1999**

PIPE CLASS.	STIFFNESS CLASS. AS/NZS 1462.22 N/m/m	NOMINAL SIZE DN	MEAN OD mm	SOCKET OD mm	INSERTION LENGTH mm	RECOMMEND USAGE
OPTIM	-	32	36.2 - 36.5	-	-	DR / COM
	-	40	42.8 - 43.1	-	-	
	-	50	55.7 - 56.0	-	-	
	-	65	68.7 - 69.1	-	-	
	-	80	82.3 - 82.7	-	-	
OPTIM	SN6	100	110 - 110.4	128.5	70	DR
OPTIM	SN10	100	110 - 110.4	128.5	70	DR / COM
OPTIM	SN16	100	110 - 110.4	128.5	70	DR / COM / TA
IMPACT	SN6	100	110 - 110.4	128.5	70	DR
IMPACT	SN10	100	110 - 110.4	128.5	70	DR / COM
IMPACT	SN16	100	110 - 110.4	128.5	70	DR / COM / TA
IMPACT PN 9	SN20	100	110 - 110.4	128.5	70	DR / COM / TA / TAC
OPTIM	SN4	150	160 - 160.5	196.0	115	DR
OPTIM	SN8	150	160 - 160.5	196.0	115	DR / COM
OPTIM	SN16	150	160 - 160.5	196.0	115	DR / COM / TA
IMPACT	SN4	150	160 - 160.5	196.0	115	DR
IMPACT	SN8	150	160 - 160.5	196.0	115	DR / COM
IMPACT	SN16	150	160 - 160.5	196.0	115	DR / COM / TA
IMPACT PN 9	SN20C	150	160 - 160.5	196.0	115	DR / COM / TA / TAC
OPTIM 2000 SC	SN16	150	160 - 160.5	196.0	115	DR / COM / TA
OPTIM 2000 SC	SN20C	150	160 - 160.5	196.0	115	DR / COM / TA / TAC
OPTIM	SN4	175	200 - 200.6	238.0	155	DR
OPTIM	SN8	175	200 - 200.6	238.0	155	DR / COM
OPTIM	SN16	175	200 - 200.6	238.0	155	DR / COM / TA
IMPACT	SN4	175	200 - 200.6	238.0	155	DR
IMPACT	SN8	175	200 - 200.6	238.0	155	DR / COM
IMPACT	SN16	175	200 - 200.6	238.0	155	DR / COM / TA
IMPACT PN 9	SN20C	175	200 - 200.6	238.0	155	DR / COM / TA / TAC
OPTIM	SN4	225	250 - 250.7	296.0	174	DR
OPTIM	SN8	225	250 - 250.7	296.0	174	DR / COM
OPTIM	SN16	225	250 - 250.7	296.0	174	DR / COM / TA
IMPACT	SN4	225	250 - 250.7	296.0	174	DR
IMPACT	SN8	225	250 - 250.7	296.0	174	DR / COM
IMPACT	SN16	225	250 - 250.7	296.0	174	DR / COM / TA
IMPACT PN 9	SN20C	225	250 - 250.7	296.0	174	DR / COM / TA / TAC
OPTIM	SN4	300	315 - 315.9	375.0	195	DR
OPTIM	SN8	300	315 - 315.9	375.0	195	DR / COM
OPTIM	SN16	300	315 - 315.9	375.0	195	DR / COM / TA
IMPACT	SN4	300	315 - 315.9	375.0	195	DR
IMPACT	SN8	300	315 - 315.9	375.0	195	DR / COM
IMPACT	SN16	300	315 - 315.9	375.0	195	DR / COM / TA
OPTIM	SN4	375	400 - 401.0	470.0	255	DR
OPTIM	SN8	375	400 - 401.0	470.0	255	DR / COM
OPTIM	SN16	375	400 - 401.0	470.0	255	DR / COM / TA
IMPACT	SN4	375	400 - 401.0	470.0	255	DR
IMPACT	SN8	375	400 - 401.0	470.0	255	DR / COM
IMPACT	SN16	375	400 - 401.0	470.0	255	DR / COM / TA

**ABBREVIATIONS**

- |             |  |              |  |
|-------------|--|--------------|--|
| SN 4 / SN 6 | - DOMESTIC RESIDENTIAL PLUMBING & DRAINAGE(DR) | SN 8 / SN 10 | - COMMERCIAL (COM)                             |
| SN 16       | - HIGH PERFORMANCE TERRITORIAL AUTHORITY (TA)  | SN 20        | - HIGH PERFORMANCE T.A. C WALL THICKNESS (TAC) |

## 3. Product Dimensions

### 3.4 DWV FITTINGS 32DN TO 150DN

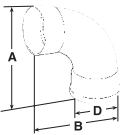
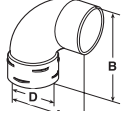
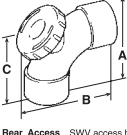
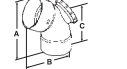
PLAIN BEND F&F	PRODUCT CODE	A	B	C	D
	101-32-15	51.90	62.50		43.10
	101-32-45	67.76	91.46		42.97
	101-32-60	67.50	101.20		43.00
	101-32-68	56.00	89.00		43.00
	101-32-88	87.03	87.03		42.83
	101-40-15	56.00	68.00		48.00
	101-40-45	95.24	96.97		50.00
	101-40-60	97.00	61.50		50.20
	101-40-88	85.20	83.04		47.83
	101-50-15	61.00	77.00		61.00
	101-50-45	114.23	114.23		62.73
	101-50-60	121.00	103.00		63.00
	101-50-68	119.20	104.00		62.40
	101-50-88	101.13	101.13		62.27
	101-65-15	77.00	96.00		75.00
	101-65-45	120.00	105.00		74.00
	101-65-88	126.92	125.37		78.91
	101-80-15	104.00	128.00		92.70
	101-80-45	147.16	142.35		92.97
	101-80-88	143.79	143.79		95.52
101-100-5	123.56	113.46		116.73	
101-100-15	156.00	127.00		123.00	
101-100-45	171.74	171.67		121.38	
101-100-60	220.00	220.00		117.60	
101-100-88	199.15	197.31		119.69	
101-150-45	257.22	255.90		173.61	
101-150-88	292.47	295.82		173.43	
<b>BEND M&amp;F</b>	<b>PRODUCT CODE</b>	<b>A</b>	<b>B</b>	<b>C</b>	<b>D</b>
	171-40-40	64.00	80.00		48.00
	171-50-40	127.00	145.70		77.80
	171-50-85	98.00	101.00		61.00
	171-65-40	98.50	115.00		75.00
	171-80-45	121.00	141.00		93.00
	171-80-88	145.00	140.00		89.00
	171-100-11	151.44	129.67		117.63
	171-100-15	113.00	142.00		122.00
	171-100-22	169.80	167.75		117.77
	171-100-30	113.00	170.00		123.00
	171-100-43	150.00	166.00		117.00
	171-100-88	210.00	201.00		123.00
	<b>REAR ACCESS BEND</b>	<b>PRODUCT CODE</b>	<b>A</b>	<b>B</b>	<b>C</b>
	101-32-88W	86.00	69.00		
	101-40-45W	65.50	92.00		
	101-40-88W	91.00	91.00		
	101-50-45W	110.80	115.00		
	101-50-88W	104.00	103.00		
	101-65-45W	123.00	138.00		
	101-65-85W	126.00	122.00		
	101-80-45W	140.00	141.00		
	101-80-88W	146.00	146.00		
	101-100-45W	154.00	184.00		
	101-100-88W	210.00	204.00		
<b>RAMP BEND</b>	<b>PRODUCT CODE</b>	<b>A</b>	<b>B</b>	<b>C</b>	<b>D</b>
	102-100-60S	224.00	200.00	94.00	

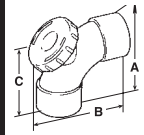
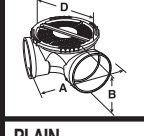
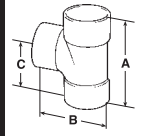
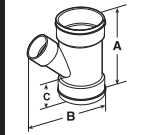
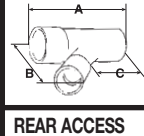
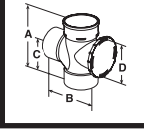
REAR ACCESS	PRODUCT CODE	A	B	C	D
	103-100-88	203.00	225.00	130.00	
<b>SIDE ACCESS</b>	<b>PRODUCT CODE</b>	<b>A</b>	<b>B</b>	<b>C</b>	<b>D</b>
	103-100-45S	249.00	140.00		200.00
	103-100-88S	197.00	147.00		201.00
<b>PLAIN JUNCTION</b>	<b>PRODUCT CODE</b>	<b>A</b>	<b>B</b>	<b>C</b>	<b>D</b>
	104-32-45	116.00	86.00	95.00	
	104-32-88	101.80	86.00	68.00	
	104-40-45	128.00	102.00	101.00	
	104-40-88	122.50	92.93	80.00	
	104-50-45	156.00	123.00	125.00	
	104-50-88	130.00	99.77	102.50	
	104-65-45	184.00	152.50	144.00	
	104-65-85	172.00	145.00	111.00	
	104-80-45	223.13	192.00	213.00	
	104-80-88	186.00	141.00	99.00	
	104-100-45	265.46	230.3	248.57	
	104-100-88	267.35	192.00	197.87	
104-150-45	395.00	345.00	330.00		
104-150-88	360.00	300.00	210.00		
<b>REDUCING JUNCTION</b>	<b>PRODUCT CODE</b>	<b>A</b>	<b>B</b>	<b>C</b>	
	104-80-50-45	194.00	166.00	57.00	
	104-100-50-88	165.60	153.00	55.00	
	104-100-50-45	227.00	186.00	72.00	
	104-100-65-45	266.00	191.00	84.00	
	104-100-80-45	266.00	205.00	75.00	
	104-150-100-45 F	330.00	290.00	100.00	
	104-150-100-88 F	320.00	255.00	100.00	
<b>REDUCING JUNCTION</b>	<b>PRODUCT CODE</b>	<b>A</b>	<b>B</b>	<b>C</b>	<b>D</b>
	104-80-50-45 M&F	193.00	168.00	56.00	
	104-150-100-45 M&F	398.00	285.00	280.00	
<b>REAR ACCESS JUNCTION</b>	<b>PRODUCT CODE</b>	<b>A</b>	<b>B</b>	<b>C</b>	<b>D</b>
	105-80-88	186.00	166.95	144.22	112.65
	105-100-88	239.89	245.73	204.61	135.26

### 3. Product Dimensions

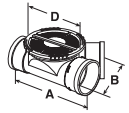
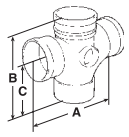
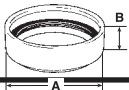
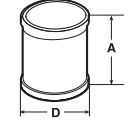
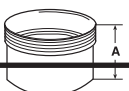
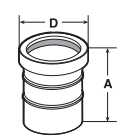
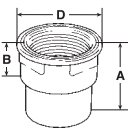
SIDE ACCESS JUNCTION	PRODUCT CODE	A	B	C	D
	105-100-45LH	266.00	252.00		201.00
	105-100-45RH	266.00	252.00		201.00
DOUBLE	PRODUCT CODE	A	B	C	D
	<b>Equal</b>				
	106-100-45	355.00	268.00	218.00	
	106-100-88	259.00	284.00	153.00	
	<b>Reducing</b>				
	106-100-50-45	246.18	194.80	122.00	
RING SEAL ADAPTER	PRODUCT CODE	A	B	C	D
	109-80	100.00	30.50		
	109-100	127.00	38.00		
STRAIGHT COUPLER	PRODUCT CODE	A	B	C	D
	110-32	54.00			43.00
	110-40	61.00			50.00
	110-50	65.50			62.50
	110-65	82.00			75.00
	110-80	94.73			93.00
	110-100	107.83			120.40
	110-150	158.40			175.00
STRAIGHT COUPLER THREADED	PRODUCT CODE	A	B	C	D
	110-100T	103.00			
EXPANSION COUPLER	PRODUCT CODE	A	B	C	D
	111-32	71.00			50.50
	111-40	78.00			57.00
	111-50	81.00			71.00
	111-65	98.00			85.00
	111-80	122.00			106.00
	111-100	127.00			130.00
	111-150	182.00			188.00
FEMALE ADAPTER	PRODUCT CODE	A	B	C	D
	112-32	51.00	25.30		53.74
	112-40	54.00	25.30		60.00
	112-50	48.00	17.00		70.00
	112-65	73.00	34.00		84.00

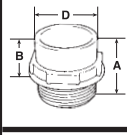
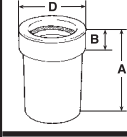
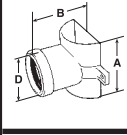
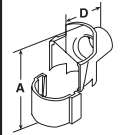
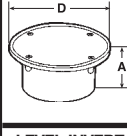
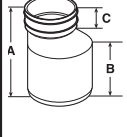
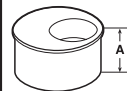
MALE ADAPTER	PRODUCT CODE	A	B	C	D
	113-32	47.00	28.00		53.50
	113-40	51.00	32.00		60.00
	113-50	54.00	36.00		74.50
	113-65	74.00	43.50		80.00
	113-80	80.50	50.00		82.77
113-100	111.00	70.00		145.75	
COPPER TO PVC CONNECT	PRODUCT CODE	A	B	C	D
	114-32	71.00	17.00		50.50
	114-40	78.00	17.00		56.00
	114-50	84.00	17.00		70.00
EXPANSION STRAP BOSS (bolted)	PRODUCT CODE	A	B	C	D
	119-80-50	102.00	105.60		70.50
	119-100-50	101.50	105.00		70.50
STRAP BOSS (solvent)	PRODUCT CODE	A	B	C	D
	119-80-50S	100.00			122.00
	119-100-50S	101.00			149.00
	119-100-65S	193.00			130.00
SEALED CLEAN OUT	PRODUCT CODE	A	B	C	D
	120-80	57.50			126.50
	120-100	67.00			168.00
LEVEL INVERT REDUCER	PRODUCT CODE	A	B	C	D
	123-40-32	63.00	28.00	30.00	
	123-50-32	89.00	32.00	30.00	
	123-50-40	80.30	32.00	31.00	
	123-65-40	100.00	38.00	31.00	
	123-65-50	90.00	40.20	33.80	
	123-80-50	105.00	46.00	33.50	
	123-80-65	100.00	47.00	41.00	
	123-100-50	150.00	52.00	34.00	
	123-100-65	142.00	63.00	41.50	
	123-100-80	135.00	62.00	47.30	
	123-150-100	234.00	121.00	53.00	
PIPE REDUCING BUSH	PRODUCT CODE	A	B	C	D
	198-100-40	56.70			
	198-100-50	56.70			

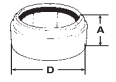
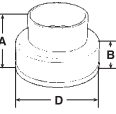
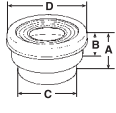
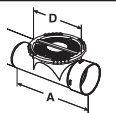
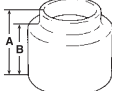

## 3. Product Dimensions

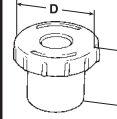
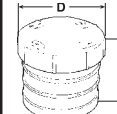
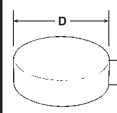
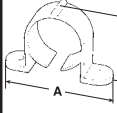
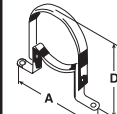
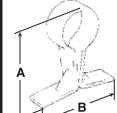
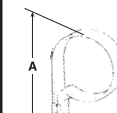
SOCKET REDUCING BUSH	PRODUCT CODE	A	B	C	D
	124-40-32	29.10			
	124-50-32	31.50			
	124-50-40	31.80			
	124-65-40	39.00			
	124-65-50	41.80			
	124-80-50	38.50			
	124-80-65	46.00			
	124-100-40	57.00			
	124-100-50	53.00			
	124-100-65	50.00			
124-100-80	53.00				
124-150-100	78.30				
PVC-CERAMIC ADAPTER	PRODUCT CODE	A	B	C	D
	124-100S	54.29			138.23
CERAMIC-PVC ADAPTER	PRODUCT CODE	A	B	C	D
	125-100S	112.00	63.00		171.00
PAN (M&F) CONNECTOR	PRODUCT CODE	A	B	C	D
	127-80	130.00	61.00		154.20
	127-100	107.80	56.70		154.30
	Offset 127M-100	114.00	25.00		153.00
	Concentric 127C-100	99.00	52.50	103.00	153.00
INSPECTION PIPE M&F	PRODUCT CODE	A	B	C	D
	129-100S	295.00	156.00		201.00
FLASHING CONE	PRODUCT CODE	A	B	C	D
	131-32	57.00	41.00		
	131-40	56.70	41.00		
	131-50	66.00	40.50		
	131-65	68.00	46.00		
	131-80	87.00	54.00		
	131-100	92.00	66.00		
	131-150	83.00	53.70		

ACCESS PLUG (spigot end)	PRODUCT CODE	A	B	C	D
	136-32	42.50			55.00
	136-40	45.00			55.00
	136-50	48.00			70.00
	136-80	30.00			113.00
	136-100	36.00			144.00
SCREW CAP & BASE (socket end)	PRODUCT CODE	A	B	C	D
	136-100S	121.88			136.00
	136-100 (cap)	35.00			134.00
	136-150S	175.00			188.00
	136-150 (cap)	35.00			187.00
PUSH ON CAP	PRODUCT CODE	A	B	C	D
	137-32	17.00			38.00
	137-40	19.00			46.00
	137-50	24.00			58.00
	137-65	22.00			75.00
	137-80	25.00			88.50
	137-100	25.00			116.00
	137-150	41.95			169.10
PIPE CLIP SADDLE	PRODUCT CODE	A	B	C	D
	140-32	74.70			49.00
	140-40	87.00			53.00
	140-50	98.00			67.00
	140-80	114.00			117.00
	140-100	158.00			142.00
2 PART HOLDER BAT	PRODUCT CODE	A	B	C	D
	140-80HB	143.00			111.40
	140-100HB	173.00			140.00
	140-150HB	220.00			188.00
PIPE CLIP STAND OFF	PRODUCT CODE	A	B	C	D
	140-32S	80.00	91.00		
	140-40S	88.00	90.00		
	140-50S	100.00	96.00		
	140-65S	98.00	139.00		
	140-80S	145.00	133.00		
	140-100S	180.00	155.00		
PIPE CLIP SIDE HANGAR	PRODUCT CODE	A	B	C	D
	140-80H	141.00			
	140-100H	178.00			

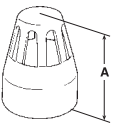
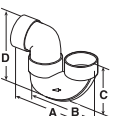
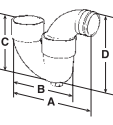
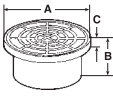
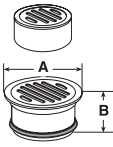
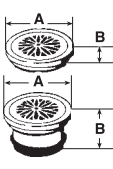
### 3. Product Dimensions

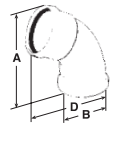
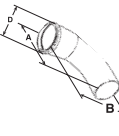
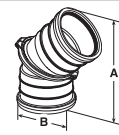
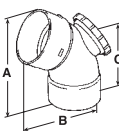
VENT COWL	PRODUCT CODE	A	B	C	D	
	150-50-40	80.00				
	150-65	71.50				
	150-80	100.00				
	150-100	90.00				
ADJUSTABLE FLOOR WASTE GULLY	PRODUCT CODE	A	B	C	D	
	159-80-50P	247.00	193.00	155.00	230.00	
	159-80-65P	260.00	193.00	150.00	230.00	
	159-100-100P	276.00	231.00	170.00	290.00	
	<b>Fixed Position</b> 159-80-80P	300.00	220.00	158.00	250.00	
ADJUSTABLE-INSPECTION FLOOR WASTE GULLY	PRODUCT CODE	A	B	C	D	
	159-80-50PW	246.00	194.00	178.00	245.00	
	159-80-65PW	235.00	169.00	121.00	220.00	
GULLY CELLAR & GRATE	PRODUCT CODE	A	B	C	D	
	<b>Loose Fit Top</b> 168-100	149.00	67.00	15.00		
	<b>Fixed pop up top</b> 168-100POP	150.30	133.00	37.50		
FLOOR GRATE VINYL FLOORS	PRODUCT CODE	A	B	C	D	
	<b>Chrome plated brass</b> 168-80-RCP	92.00	43.60			
	168-100-RCP	122.00	50.00			
	<b>White PVC</b> 168-80RAM	93.50	17.00			
	168-100RAM	117.80	17.60			
FLOOR GRATE TILE FLOORS	PRODUCT CODE	A	B	C	D	
	<b>Round (white PVC)</b> 168-80R	100.00	60.00			
	169-100R	117.80	72.50			
	<b>Bevelled (white PVC)</b> 169-80	100.00	60.00			
	169-100	130.00	70.00			
	<b>SQ chrome plated brass</b> 169-80SCP	94.00	44.00			

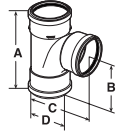
4 WAY BOSS JUNCTION M&F	PRODUCT CODE	A	B	C	D
	170-80-50-40-88	164.00	143.00	86.00	
	170-100-50-40-88	182.00	175.00	101.00	
	170-100-80-50-40	175.50	174.00	112.50	
PLAIN BEND F&F	PRODUCT CODE	A	B	C	D
	1501-100-45	196.00	171.00		127.00
	1501-100-60	238.00	245.00		133.50
	1501-100-88	214.00	214.00		128.00
	1501-150-45	260.00	230.00		183.00
	1501-150-88	300.00	300.00		183.00
M&F SPIGOT BEND	PRODUCT CODE	A	B	C	D
	1571-100-5	148.00	158.00		130.00
	1571-100-11	142.00	163.00		132.00
	1571-100-15	154.00	183.00		130.00
	1571-100-22	136.00	183.00		133.00
	1571-100-30	196.00	199.00		130.00
	1571-150-15	209.00	247.00		188.00
ADJUSTABLE BEND	PRODUCT CODE	A	B	C	D
	1501-150A	269.00	269.00		
RAMP BEND	PRODUCT CODE	A	B	C	D
	1502-100-60	250.00	150.00		
	1502-100-88	244.64	180.00		
SIDE ACCESS BEND	PRODUCT CODE	A	B	C	D
	1503-100-45	254.00	145.00	190.00	
	1503-100-88	211.50	145.00	148.00	
PLAIN (P&F) JUNCTION	PRODUCT CODE	A	B	C	D
	1504-100-45	292.50	275.00	238.50	128.00
	1504-100-88	264.70	218.00	213.00	127.00
	1504-100-45-F	390.00	330.00	355.00	183.00
	1504-100-88F	350.00	270.00	295.00	183.00
	<b>Reducing</b> 1504-150-100Y	390.00	280.00	300.00	183.00

## 3. Product Dimensions

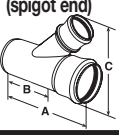
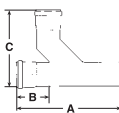
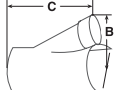
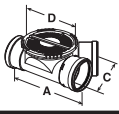
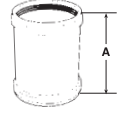
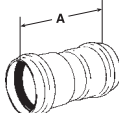
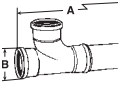
PLAIN JUNCTION	PRODUCT CODE	A	B	C	D
 (spigot end)	1504-150-45	435.00	295.00		160.00
	1504-150-88	435.00	270.00		160.00
LUNDEN JUNCTION	PRODUCT CODE	A	B	C	D
 (spigot end)	1504-100-LJ	740.00	230.00	500.00	
	1504-150-LJ	698.00	240.00	520.00	
	<b>Heavy duty</b> Z1505H-150-LJ	740.00	230.00	500.00	
	Z1504H-150-100LJ	698.00	240.00	520.00	
PVC-PVC REDUCING SADDLE	PRODUCT CODE	A	B	C	D
	1504S-150-100	365.00	210.00	280.00	
SIDE ACCESS JUNCTION	PRODUCT CODE	A	B	C	D
	1505-100-45LH	292.00	127.80	245.00	
	1505-100-45RH	292.00	127.80	245.00	
COMBINATION STANDARD/SLIP COUPLER	PRODUCT CODE	A	B	C	D
	1511-100C	160.00			
	1511S-150	236.00			
RING SEAL COUPLER	PRODUCT CODE	A	B	C	D
	1511-150	235.00			
	<b>Heavy duty</b> Z1511H-150	235.00			
SEPTIC TANK JUNCTION	PRODUCT CODE	A	B	C	D
	1514-100-88	665.00	210.00		

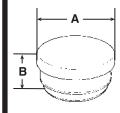
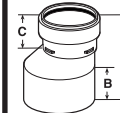
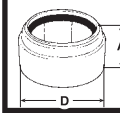
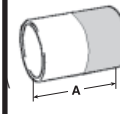
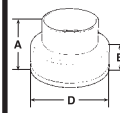
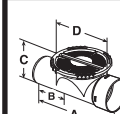
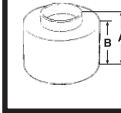
FRESH AIR INLET	PRODUCT CODE	A	B	C	D
	1516-100	152.00	102.00		
LEVEL INVERT REDUCER	PRODUCT CODE	A	B	C	D
	1523-100-80	135.00	62.00	47.30	
	1523-150-100	222.00	98.00	65.00	
PVC-CERAMIC ADAPTER	PRODUCT CODE	A	B	C	D
	1524-100	73.00			137.00
	1524-150	263.00			192.00
PRESSURE/SEWER ADAPTER	PRODUCT CODE	A	B	C	D
	1524-114-100	123.00			
CERAMIC-PVC ADAPTER	PRODUCT CODE	A	B	C	D
	125-100S	112.00	63.00		171.00
ACCESS PIPE M&F	PRODUCT CODE	A	B	C	D
	1529-100	305.00	152.00	140.00	201.00
	1529-150	415.00	209.00	260.00	186.00
SOCKET PLUG	PRODUCT CODE	A	B	C	D
	1530-100	88.00	72.00		

### 3. Product Dimensions

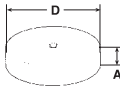
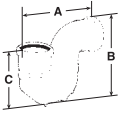
PUSH ON CAP	PRODUCT CODE	A	B	C	D
	137-100	25.00			117.00
	137-150	42.00			170.00
GULLY TRAP	PRODUCT CODE	A	B	C	D
	1559-100	330.00	300.00	220.00	

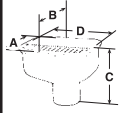
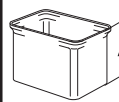
GULLY DISH	PRODUCT CODE	A	B	C	D
	<b>Complete</b>				
	1575-100	214.00	135.00	252.00	300.00
	<b>Lid only</b>				
1575L-100	199.00	120.00		284.00	
GULLY RISER	PRODUCT CODE	A	B	C	D
	1575R-100-100	100.00			
	1575R-100-200	200.00			
	1575R-100-300	300.00			

#### FWG INSTALLATION DETAIL

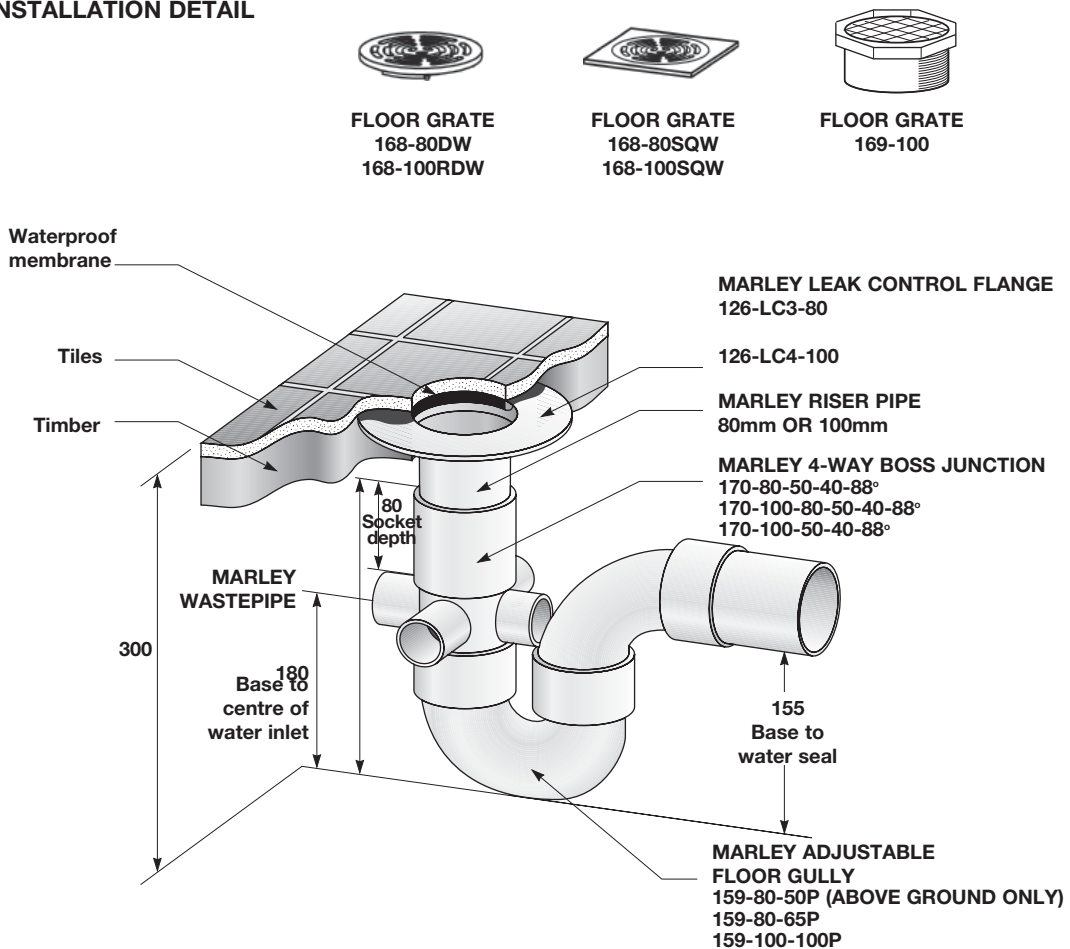

## 4. Installation - Waste & Vent

---

### SCOPE:

This section covers various aspects of pipe installation and design protocols according to the AS/NZS 3500.2.2003 for waste and vent applications. Though detailed in scope, this section only serves as a guide to general design criteria and reference to AS/NZS 3500.2.2003 is recommended.

#### *Reference Documents*

- NZ Building Code G13 Foul Water
- AS/NZS 3500.2.2003 Sanitary Plumbing and Drainage - AS1 + AS2, VM1 + VM2

### INTRODUCTION

#### 4.1 Wastes and Vents Above Ground

Plumbing Definition: Pipes above ground floor slabs, including individual waste pipes from fixtures into a floor waste gully.

A plumbing system designed in accordance with AS/NZS 3500.2.2003 utilises appropriately sized pipes and fixture traps and offers architects, engineers and installers considerably more flexible design options.

#### 4.2 AS/NZS 3500.2.2003

AS/NZS 3500.2.2003 offers design flexibility in that:

- Fixtures can more easily be sited internally up to 20m unvented, via a sealed ORG (overflow relief gully) from the main drain to the seal of the fixture trap.
- The number of vents required is reduced.
- Floor drains can be used as shower wastes.
- Under-slab drainage installation is provided without the need for ducting of pipes.
- The size of terminal vents is reduced.
- External gully traps are minimised.
- The number of access junctions required is reduced.
- The number of fixture traps can be reduced.
- The risk of surface stormwater invasion of sewer systems and the likelihood of mis-connections are minimised.

AS/NZS 3500.2.2003 offers considerable cost savings:

There are three important features of AS/NZS 3500.2.2003 that make up its key differences for residential and low rise commercial applications:

1. The use of a trapped floor waste gully trap (FWG) as a common internal collection point for waste water fixtures that occur within the same room as the FWG.
2. Ground floor fixtures (except kitchen sinks and dishwashers) may be connected directly to the vented house drain, thereby eliminating individual back vents and minimising external gully traps.
3. Fixtures on elevated timber or upper floors may be connected together on a “roll-over” single-stack vented system and then connected directly to the house-drain, eliminating individual back vents and minimising waste pipe and external gully traps.



## 4. Installation - Waste & Vent

### 4.3 Floor Waste Gully (FWG) Layout

Floor waste gullies are generally used to drain wet areas.

Risers and riser boss junctions must sit vertically between the floor grate and the gully trap. The riser boss junction takes the individual fixture waste pipes into the gully riser. The diameter is determined by the proximity of the highest inlet pipe to the top of the floor grate. The higher the inlet the greater the diameter of the riser.

Height of gully riser: The height of the riser shall be measured from top of water seal to the floor surface level and shall comply with the following:

- The maximum height shall comply with the Table Below.
- The maximum height shall be 600 mm.

Minimum outlet size of floor waste gully traps

Waste fixtures connected to gully riser	Size of gully riser	Minimum height (water seal to floor level) 881/2° entry
	DN	
All permitted waste fixtures including maximum one bath	80	200
	100	150

Where excessive foaming is likely to occur, a washing machine discharge pipe should be connected directly into either a branch or main drain.

#### Typical Wet Area Layout for AS/NZ 3500.2.2

Figure 4.1

INDIVIDUAL FIXTURE WASTE PIPES

DIAMETER - DN40 min

LENGTH Trapped 2.5M

Untrapped 1.2M

NOTE:  
Kitchen waste must not be connected to a floor waste gully

(Basin waste must be trapped)

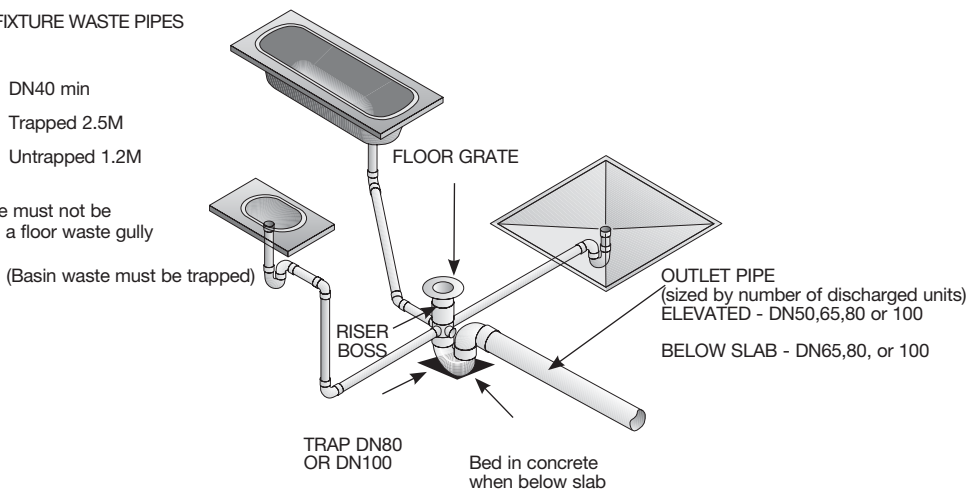

### 4.4

#### DISCHARGE PIPE SIZING

Minimum outlet size of floor waste gully traps

Total fixture unit rating of waste fixtures connecting to floor waste gully	Outlet size of floor waste gully trap
3	DN 50
10 including 1 Bath	DN 65
10 or more	DN 80 or greater

#### The Floor Grate:

A removable floor grate of 80mm or 100mm diameter (depending on the size of the riser) is set flush to the floor at the top of the riser.

#### Floor Seal Flanges:

Products such as leak control flanges may also be required for elevated timber and concrete floors, to ensure compliance with NZBC requirements.

#### The Gully Trap:

A standard P-type trap of DN80 or DN100 diameter. The outlet size is determined by the total number of fixture discharge units through the FWG.

## 4. Installation - Waste & Vent

### 4.5 Fitting Detail for Grate, Riser and Boss Junction

Marley FWG Assembly:

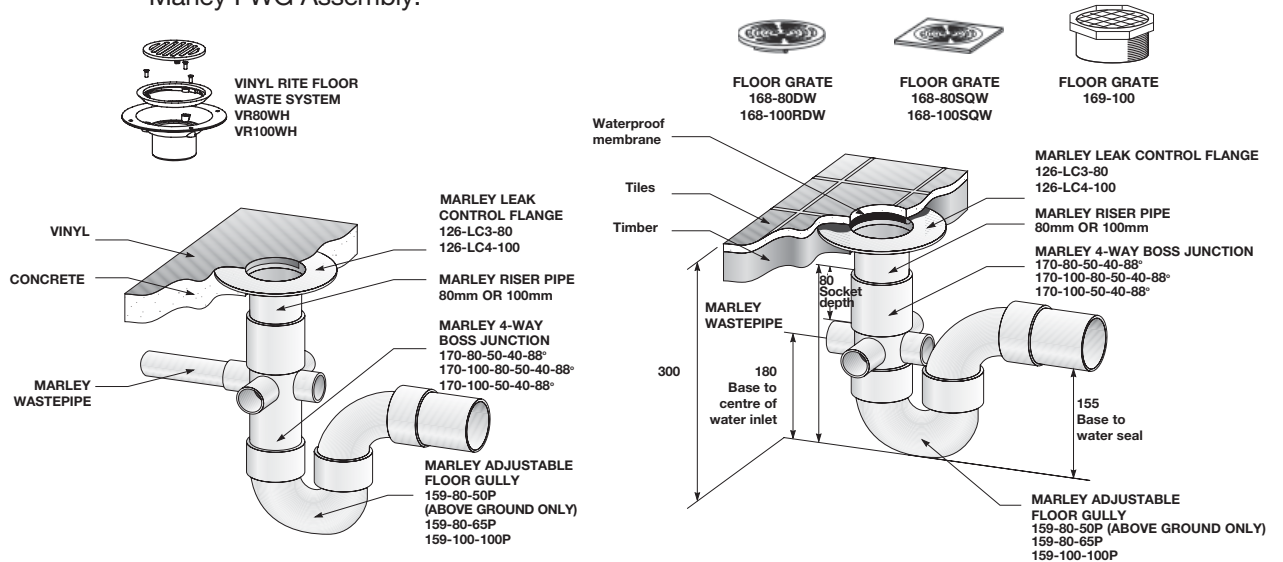

### 4.6 Typical Layout of Ground Floor Drainage (minimum pipe sizes and maximum permissible lengths)

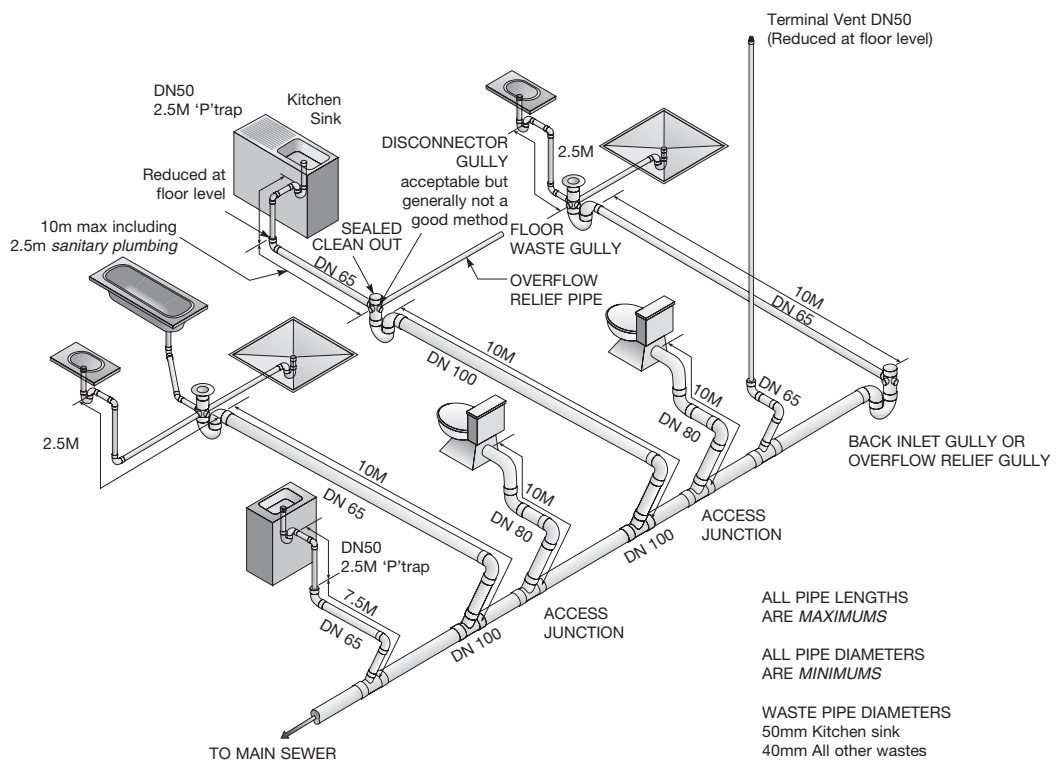

### 4.7 Fixture Detail

#### 4.7.1 Basins:

AS/NZS 3500.2.2 All wash basins and drinking fountains must be trapped, whether discharged through a floor waste gully or directly connected to a drain or stack.

## 4. Installation - Waste & Vent

### 4.7.2 Floor Waste Gully (FWG):

Shall have no more than 2 bends in a horizontal plane and 3 bends in a vertical plane, to collect discharge from waste fixtures within the same room, with a maximum of 10m of pipe from the main drain before venting.

### 4.7.3 Baths, Showers and Washing Machines:

These can all be run in DN40 or DN50 diameter pipe, either directly to a main drain or stack, or into a floor waste gully and from there, via a minimum DN65 diameter branch drainage pipe, directly to the main house drain or to an Overflow Relief Gully.

NOTE: Where excessive foaming is likely to occur, a washing machine discharge pipe should be connected directly into either a branch or main drain.

### 4.7.4 Kitchen Sinks:

AS/NZS 3500.2.2 requires that all kitchen sink outlets, traps and waste pipes are minimum DN40 and may connect directly to the main house drain via a larger branch drain pipe or through an Overflow Relief Gully. Kitchen sinks and dishwashers may not discharge into an FWG.

### 4.7.5 Laundry Tubs:

Laundry tub wastes may be run in either DN40 or DN50 into its own Floor Waste Gully or preferably directly into the main house drain (due to foaming) via a larger branch drain, or through an Overflow Relief Gully.

### 4.7.6 Bends:

Fixtures other than basins and bidets, shall have no more than 2 bends on a horizontal plane and 3 bends on the vertical plane.

NOTE: A bend of 45° or less is not considered as a change of direction or grade.

### 4.8 Waste Pipe Discharge

Fixtures on either the upper floor or on the ground floor can be connected to the house drain via individual waste pipes to an external gully. However, waste pipes to an external gully must run above the ground floor slab level.

Allowable distances for this type of connection vary according to whether they are vented or unvented.

Unvented Fixtures		
Size	Fixtures	Distance
DN40	Basin	3.6m
DN 40	All Fixtures for these sizes	6.0m
DN 50	All Fixtures for these sizes	6.0m
DN 65	All Fixtures for these sizes	10m

Alternatively utilising a floor waste gully will allow the total distance from the main drain or stack to be 10m. A fixture trap connected to a FWG will provide an additional 2.5m when measure from the wier of the fixture trap.

### 4.9 Waste Stacks Refer AS/NZS 3500.2.2

Waste stacks must be sized so that they receive the discharge from waste fixtures and have the size, length and grade of the discharge pipe identical to the single stack system.

#### 4.9.1 Sizing of Stacks Refer AS/NZS 3500.2.2

It should be noted that not more than 1/4 of the maximum loading is to discharge into the stack at any one floor level.

## 4. Installation - Waste & Vent

Size of Stack	Maximum Fixture Unit Loading
40mm	2
50mm	6
65mm	15
80mm	30
100mm	120

### 4.9.2 Waste Stacks 65mm (Refer AS/NZS 3500 2.2 Clause 8.8.8)

65mm waste stacks can receive the discharge from kitchen sinks and laundry tubs, provided that:

- The stack does not exceed 2 floor levels, and
- no more than 2 kitchen sinks or 1 kitchen sink plus 1 laundry tub are separately connected at each floor level.

### 4.9.3 50mm Vertical Section of a Soil & Waste Stack

Refer AS/NZS 3500 2.2 clause 8.8.9.

A maximum of 3 waste fixtures, basins, showers or kitchen sinks may be connected to the top of a 50mm vertical section of a stack, provided that the stack does not exceed 3 floors or does not exceed 30 fixture unit loading.

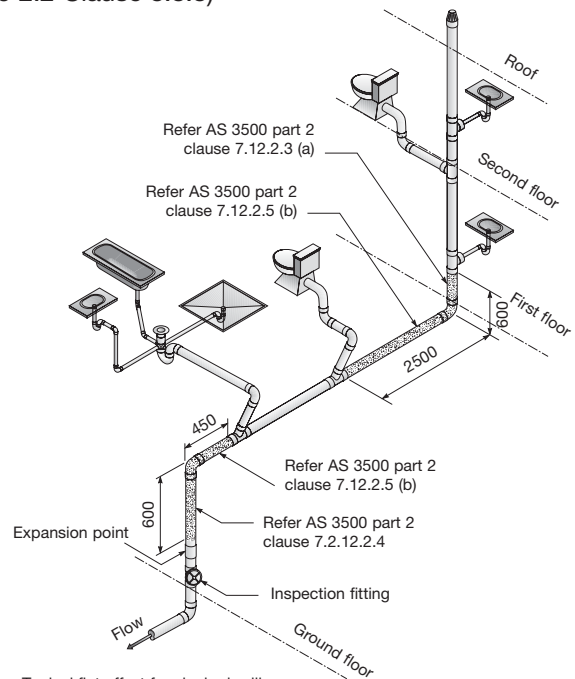

Typical flat offset for single dwelling with sanitary stackwork up to two floors

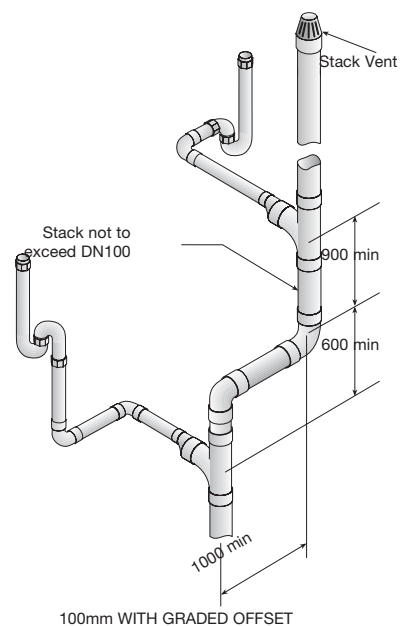
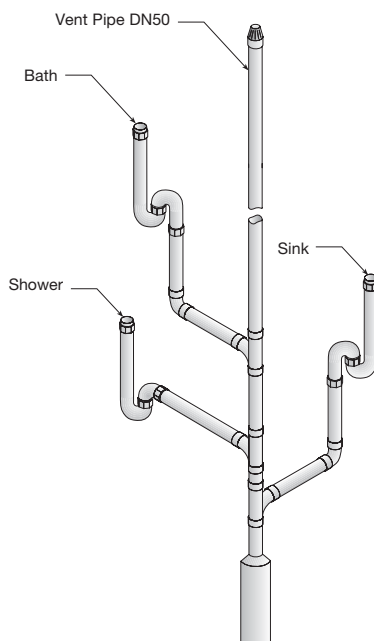

ALL DIMENSIONS IN MM

## 4. Installation - Waste & Vent

---

### 4.10 Above In and Below Concrete Slab Installation Detail

In these installations, consideration should be given to catering for expansion and contraction by one of the following methods:

*“Below” Slab Installations:*

Firm bedding in clean sand using sleeving and/or dry packing where pipes penetrate the slab, or install a larger outer ducting to carry the service pipe.

*“In” Slab Installations:*

Install a larger duct to carry the service pipe or wrap the pipe in polyethylene, felt densotape or foam membrane.

*Under Slab:*

Any pipe running under a concrete slab floor from a fixture directly to the main house drain is deemed to be a “drain”. As such it must be at least DN65 and connected as if a drain.

Other important points to remember in connection with installations in or under concrete slab floors:

- a) Any waste pipe running to an external gully must run above the slab for its entire length, or considered a drain if dropped below slab level.
- b) Individual waste pipes running under a concrete slab floor from a fixture to an FWG are simply considered an extension of the above-floor waste pipe and may be treated as such.
- c) All pipes in or below concrete should be installed in straight runs.
- d) Expansion and contraction of PVC drains must be catered for when installing in concrete.

### 4.11 Important Design Considerations

1. Kitchen sinks and WCs cannot discharge into an FWG.
2. All basins and any drinking fountains must always be individually trapped.
3. Fixtures (other than in 2 above) with outlets 1.2m or less from the FWG do not require traps.
4. All fixtures with outlets between 1.2m and 2.5m from an FWG must be trapped.
5. All waste pipes discharging to an FWG must be a minimum of DN40.
6. Fixtures discharging to an FWG must be located in the same room as the FWG.
7. Individual fixture pipes to an FWG should be as straight as possible.
8. Under a slab, changes in direction, if required, should be made at the riser boss.
9. No venting is permitted on any individual waste pipes discharging to an FWG.
10. A floor waste gully assembly may be used as an “in floor” shower outlet.
11. The discharge pipe from an FWG to the main drain is sized by the number of fixture units entering the FWG. Minimum pipe size is 65DN.
12. Where foaming is likely to cause a problem, fixtures should not discharge through an FWG.

## 4. Installation - Waste & Vent

### 4.12 Gully Traps

The gully trap is to be constructed so as to ensure no surface water or foreign bodies are likely to cause a blockage.

The top must be at least 25mm above the paved surround area or 100mm above the area if it is undeveloped, Discharging waste pipe through the back of a gully dish is not acceptable.

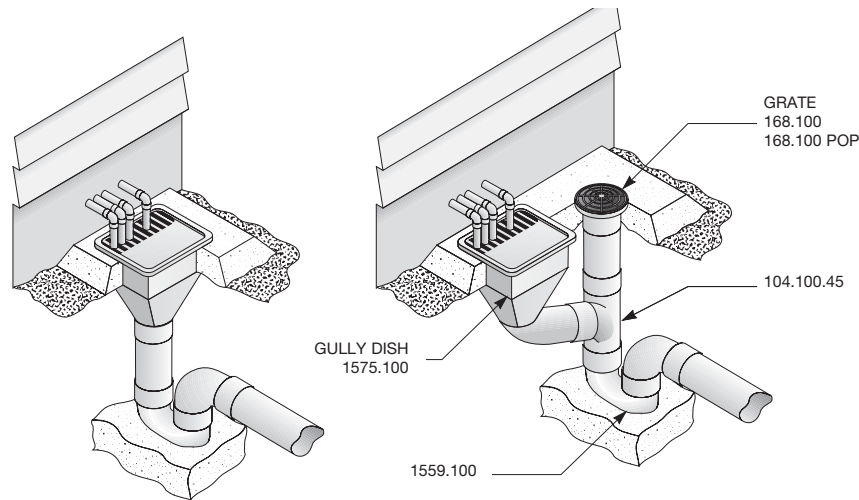

### 4.13 Overflow Gully and Overflow Relief

In AS/NZS 3500.2.2 often referred to as a back inlet gully. It is described as having a 100x65x88 degree junction fitted in the vertical riser of a gully trap.

*Location:* One overflow relief gully is required per property. Located as far as practicable from the downstream end of the main drain, the overflow relief gully acts as a “nuisance” overflow spill point should the main drain block or surcharge occur.

TYPICAL EXTERNAL OVERFLOW RELIEF GULLY LAYOUT  
(refer to AS/NZ 3500 PT 2.2 for heights and distances.)

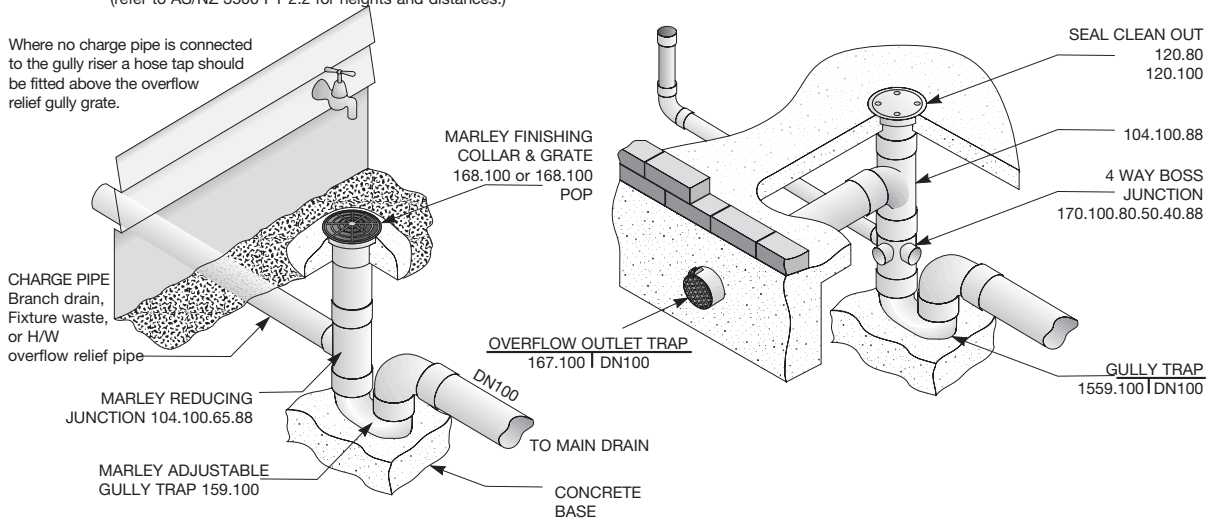

## 4. Installation - Waste & Vent

### 4.14 The Roll-over Single Stack System Without Individual Venting

“Roll-over” single-stack systems are acceptable for below concrete and timber floors and are permitted for use only on ‘residential’ type buildings.

While the distance allowances make individual connections to gullies possible in most situations, AS/NZS 3500.2.2 is framed to make it more sensible and economic to utilise a soil stack wherever available.

This design option reduces costs by combining soil and waste fixtures into a single stack and eliminating the expense of unnecessary venting. It allows a stack to be laid (rolled over) horizontally to run under the floor, taking the most direct and economical course possible to minimise the length of each fixture discharge pipe.

#### Maximum Length and Grade of Unvented Branches

The permitted lengths of unvented fixture discharge pipes connecting directly to the stack vary depending on use and diameter:

Fixture	Maximum Length (Metres)	Permitted Grade
Water Fixtures	2.5	1:40 - 1:20
Water Closets	2.5	1:40 - 1:20
100mm Outlet	6.0	1:60
80mm Outlet	2.5	1:60

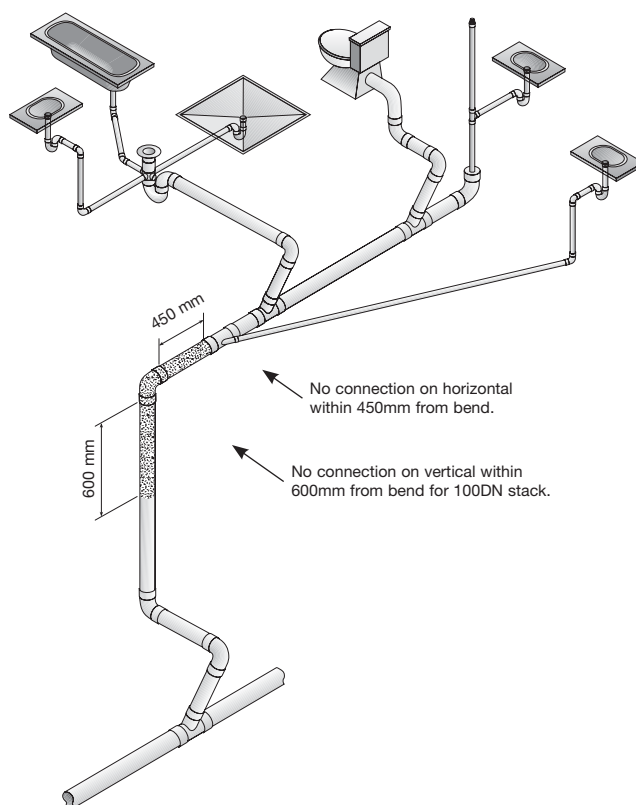

## 4. Installation - Waste & Vent

### 4.15 80mm Roll-over Stacks

- Every waste fixture is to be connected either individually to the stack or through an FWG, an unequal oblique junction or fixture pairs.
- No laundry tub or clothes washing machine can be connected.
- No fixtures are connected to the stack's lower vertical section.
- Only one of each of the following fixtures may be connected to the stack's horizontal section:
  - Bath
  - Kitchen sink
  - Basin
  - Shower
  - Dishwasher
  - Water closet pan
- No connection is to be made in the horizontal section of the stack within 450mm of the stack's downstream bend.

If these conditions cannot be met then an unvented 80mm roll-over stack system is inappropriate. The alternatives are either to vent all fixtures or to install a 100mm stack, for which there are fewer limitations.

### 4.16 100mm Roll-over Stacks

*Residential building of no more than two floors.*

No individual trap vents are required in a 100mm roll-over stack system, provided the following conditions are met:

- Every waste fixture is to be connected either individually to the stack or through an FWG, fixture pairs, or an unequal oblique junction.
- No connection is to be made on the horizontal section within 450mm of the stack's down-stream bend.
- Branches must not connect within the top 600mm of the vertical section of the stack.

### 4.17 Restricted Entry Zones

Restricted Entry Zone Requirements - Refer AS/NZS 3500.2.2 Table 6.4.

Discharge Pipe Nominal Size mm	Stack Size mm	Restricted Entry Zone Vertical Depth mm
40 to 65	40 to 80	90
40 to 65	100	110
80 or larger	80 or larger	200

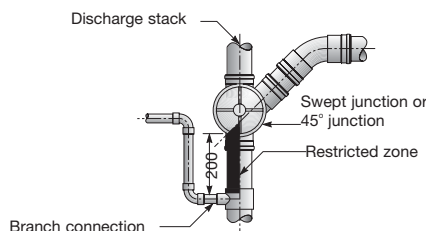
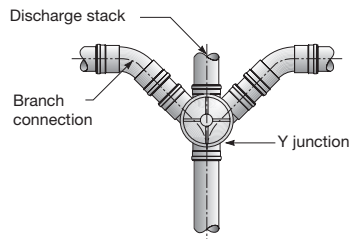



## 4. Installation - Waste & Vent

### 4.18 Inspection Openings (Refer AS/NZS 3500.2.2 Clause 9.5.1 A-E)

All pipes conveying soil discharges should have inspection openings located as follows:

- Where required for testing.
- At junctions that connect any graded pipe or branch to a stack.
- At least 30m intervals on grade pipes.
- At the base of every stack.
- At the first bend downstream from the soil fixture trap outlet.
- At the upstream section of such grade pipe or branch.

### 4.19 Rating of Vents

Where two or more vents are directly connected to a drain, these vents may take the place of the single vent. The sum of the ratings must be equal to or greater than the vent rating for the single vent.

#### Size and Rating of Vents

Size of Vent Pipe DN	Fixture Units Discharging to Drain	Vent Rating
40	<1 ≤10	0.5
50	<10 ≤30	1
65	<30 ≤175	2
80	<175 ≤400	3
100	<400	

### 4.20 Vents

The vent must extend to the approved point above the roof. The vent is to be installed so as to ensure atmospheric conditions always exist in the stack.

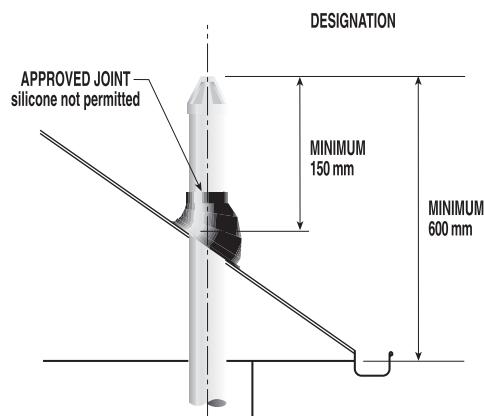

### 4.21 Expansion Joints

These are required at or immediately adjacent to each entry to a vertical stack, another grade line or a fixed point, except for straight runs of less than 2m.

## 4. Installation - Waste & Vent

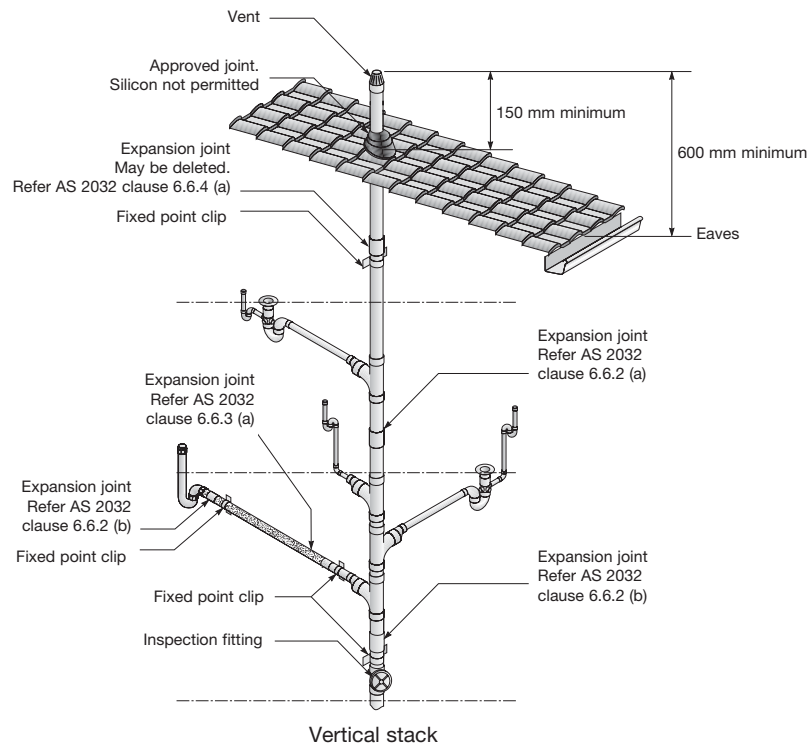

### 4.22 Bracket Spacing

Bracket spacing in metres in accordance with AS/NZS 3500.2.2		
Nominal pipe size	Graded Pipe	Vertical Pipe
40	1	2
50	1	2
65	1.2	2.5
80	1.2	2.5
90	1.2	2.5
100	1.2	2.5
150	1.2	2.5
175	1.7	2.8
200	2.0	3.1
225	2.2	3.4
250	2.3	3.6
300	2.5	4
375	3.0	4.4

#### 4.22.1 Bracket Spacing Above Ground Installations for Rollover Stacks

Pipe support should be as per Table 4.22. However, fittings support needs to be included at every junction and change of direction. When the gradient is below 1:20 or the line is subject to heat loading from dishwasher or similar appliances.

## 4. Installation - Waste & Vent

### 4.23 General Requirements For a Single Stack System.

Commonly used fixtures			
Fixture	Size of trap & fixture discharge pipe DN	Fixture unit rating	Max. length of unvented fixture discharge pipe in metres
Basin	32 or 40	1	2.5
Bath	40	4	2.5
Shower	40 or 50	2 per shower rose	2.5
Kitchen Sink	40 or 50	3	2.5
Laundry Tub	40 or 50	5	2.5
Water Closet Pan	100	6 (flush valve) 4 (cistern)	6
Bidet	32 or 40	1	2.5
Water Closet Pan	80	6 (flush valve) 4 (cistern)	2.5

### Other Fixtures

Fixture	Size of trap & fixture discharge pipe DN	Fixture unit rating	Max. length of unvented fixture discharge pipe in metres
Autopsy Table	50	3	2.5
Bain-Marie	40	1	2.5
Bath (baby)	40	3	2.5
Bath (shower)	40	4	2.5
Ben Pan Steriliser	50	4	2.5
Bed Pan Washer	80	6 (flush valve) 4 (cistern)	2.5
Bed Pan Washer	100	6 (flush valve) 4 (cistern)	6.0
Bed Pan Washer Steriliser	80	6 (flush valve) 4 (cistern)	2.5
Bed Pan Washer Steriliser	100	6 (flush valve) 4 (cistern)	6.0
Circular Wash Fountain	50	4	2.5
Clothes Washing Machine	40	3	2.5
Domestic Commercial	50	Table 6.2	2.5
Dental Unit	40	1	2.5
Dishwashing Machine			
Domestic Commercial	40	3	2.5
	50	Table 6.2	2.5
Drinking Fountain	40	1	2.5
Floor Waste Gully			
Without Fixtures	50 to 100	0	2.5
With Fixtures	Up to 100	As per fixture rating	2.5
Glass Washing Machine	40 or 50	3	2.5

## 4. Installation - Waste & Vent

Fixture	Size of trap & fixture discharge pipe DN	Fixture unit rating	Max. length of unvented fixture discharge pipe in metres
Sink Single or Double with or Without Disposal	40 or 50	3	2.5
Tea Sink	50	1	2.5
Domestic Bar Sink	40	1	2.5
Commercial Bar Sink	50	3	2.5
Cleaner Sink	40 or 50	1	2.5
Laboratory Sink	50	1	2.5
Sink (Pot or Utility)	50	5	2.5
Slop Hopper	100	6 (flush valve)	6.0
Trough (Ablution)	32, 40 or 50	3	2.5
Trough (Laundry)		5	
Urinal Wall hung	50 or 80	1	2.5
Urinal, Stall or each 600mm Length of Slab Bathroom	100	1	6.0
Combination in a single room (Basin Bath, Shower, WC) Combination Pan		6	
Room, Sink & Flushing Bowl	80	6 (flush valve) 4 (cistern)	2.5
Combination Pan Room Sink	100	6 (flush valve) 4 (cistern)	6.0

*Notes:*

## 5. Installation & Layout - Drains

### DRAINS BELOW GROUND

#### 5.1 Inspection Openings

Marley inspection openings are to be installed at:

- Not more than 30 metre intervals where soil fixtures are connected.
- Outside the building on branches connecting one or more water closets, but no greater than 2.5m away from the building.
- On the downstream end where any drain passes under a building, except where waste fixtures only are connected.
- Where any new section of drain is connected to any existing drain.

#### 5.2 Bends

Any pipe layout must be planned to reduce the risk of blockages.

- Use the least number of bends by planning a simple layout.
- Use the maximum bending radius in all bends installed to minimise blockage potential.
- Lay in straight lines between bends (both horizontally and vertically)

#### 5.3 Junctions

Any connection must be made by means of a sweep inspection junction, or Marley London junction on a main line. The angle that the branch makes with the main drain shall not be greater than 60°.

#### 5.4 Gradient - Number of Discharge Units

All sanitary drains should be laid at a minimum gradient of 1:60 or greater if practical. Lower gradients can be used but they will have an effect on the number of discharge units that can be connected.

Dia DN	Gradient				
	1:20	1:40	1:60	1:80	1:100
80	215	100	61	44	34
100	515	255	205	149	122
150	2920	1790	1310	1040	855

#### 5.5 Excavation

The recommended trench depth should be determined by the proposed surface-imposed loading plus the soil loading based on the depth. The depth should be sufficient to ensure there is no damage to the pipe during its intended service life. See section 10.7 for maximum recommended depth and embedment compaction.

#### 5.6 Excavation - Special Conditions

Trench support requirements must be observed. OSH have standard guidelines for installers, safety and these should always be complied with.

When shoring or stepping is used, care needs to be taken that no voids are left as the shoring is removed and the compaction density of the backfill is achieved.

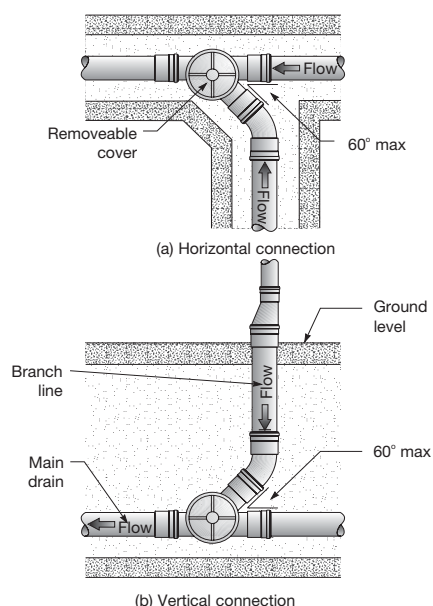

## 5. Installation & Layout - Drains

### 5.7 Trench Width

Trench width should be as narrow as practical, leaving enough space each side of the pipe to allow for compaction. Narrower trenches result in less disruption to local services, achieve faster excavations and minimise loads imposed on the pipe.

The minimum trench width is 200mm wider than the pipe

Nominal Diameters	Narrow Trench Width (mm)	Wide Trench Width (mm)
100	310	800
150	360	830
175	400	900
225	450	950
300	515	1000
375	600	1200

### 5.8 Pipe Laying

Before pipe installation, each pipe should be checked to see that its bore is free from foreign matter and that the pipe exterior and the socket have not been damaged in handling or storage.

Pipes should be laid in straight lines between bends both horizontally and vertically.

### 5.9 Pipe Bed Preparation

The pipe bed should give firm, even support. The trench should be excavated 80-150 mm below the invert to allow pipe bedding material to be placed.

Where the natural ground provides an inadequate foundation, the trench should be over excavated and selected hardfill compacted in place to provide adequate pipe support. Compact hard fill should be used to make up for any over excavation of the trench.

A groove should be dug under each socket ring groove to ensure the pipe barrel is uniformly supported along its length.

### 5.10 Bedding

The pipe bedding material should be non-cohesive (free running), granular, crushed rock, free from sharp stones larger than 25mm and free from lumps of clay or soil larger than 75mm. The material excavated from the trench may be reused if dry, well broken and free of lumps which would prevent adequate compaction or create point loads. When bedding with fine sand, special precaution is required to ensure that this material is not washed into the rubber ring seal.

### 5.11 Side Support and Backfill

Bedding material should be used for side support, and should be tamped each side of the pipe to a minimum height of 150mm above the crown of the pipe. Particular care must be taken not to leave any voids or disturb the line or gradient or damage the pipe.

Special care is required with large diameter pipes to ensure the side support is adequately compacted to minimise pipe ovality when the backfill is compacted to the density requirement.

When the pipe has passed the required testing and the pipe and fittings are covered and tamped with appropriate side fill, backfilling with excavated or imported material (depending on loading requirements) can proceed.

## 5. Installation & Layout - Drains

No mechanical compaction should proceed until at least 300mm of backfill has been placed over the sidefill.

### 5.12 Pipe Cover

Trenches must be excavated to a depth to allow for the appropriate bedding depth, the nominal pipe diameter and sufficient cover to meet the performance requirements.

#### SHALLOW TRENCH CONFIGURATION

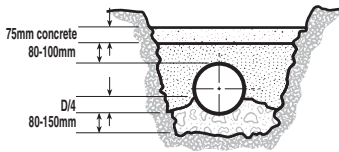

#### WIDE TRENCH CONFIGURATION

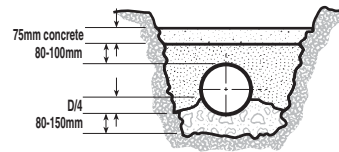

#### Minimum Cover

Location	Depth of Cover	
Not subject to vehicular loading	300	
Subject to vehicular loading	- not in roadways	450
	- in sealed roadways	600
	- under unsealed roadways	750
Pipes in embankment conditions or subject to construction equipment loading.	750	

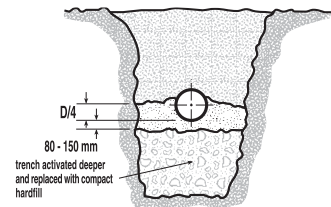

**TRENCH IN POOR FOUNDATION SITUATION**

### 5.13 Anchoring On Steep Slopes

Problems can occur when pipes are laid on gradients steeper than 1 : 5 (20%) :

- Pipes can slide down the hill during construction or after installation, potentially causing disengagement of the spigot and socket. To avoid this, each pipe should be firmly held, with special bedding, or haunching with concrete or fastenings.
- Special care needs to be taken on all steep installations as bedding back filling can be scoured out. Clay, concrete or sandbag stops should be placed at appropriate intervals above and below the pipe to stop the erosion of the backfill. Lime or cement stabilised backfilling material may be used.

Pipelines on steep slopes

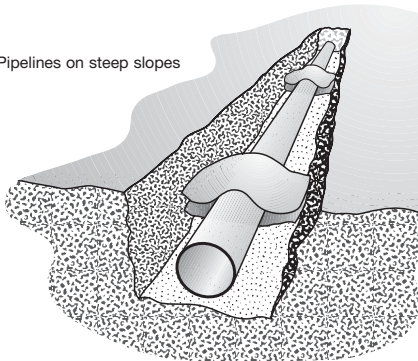

Anchor spacing	
Gradient	Every
1 in 2	5.5m
1 in 4	11.0m
1 in 6	22.0m

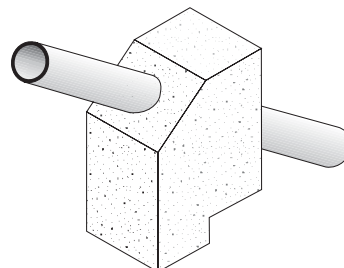

## 5. Installation & Layout - Drains

### 5.14 Pipe Bending Radius

Before attempting to induce any curvature, always joint two pipes when they are straight, to avoid dislodging the rubber ring. Rubber ring joints can be deflected up to 3%. Greater changes in direction can be achieved using shorter pipe lengths or formed bends. For smaller pipe sizes, PVC is flexible enough to be subjected to limited bending. The curvature induced should take place over the full length of the pipe.

Joints should be well compacted or sand bagged to ensure that the joint is not deflected more than 3°.

The minimum bending radius of 300 times the diameter should not be exceeded, ie 100mm pipe recommended minimum radius of 30m.

### 5.15 Jointing Into a Concrete Manhole

In order to relieve stress caused by differential settlement between heavy concrete structures and a PVC drain, Rocker pipes or shorts should be used. (Check with Territorial Authority for the approval method.)

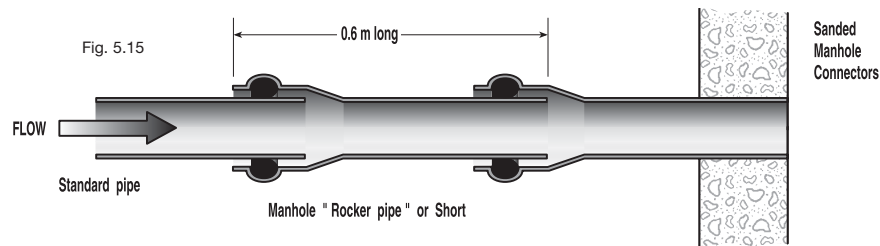

*Notes:*



## 6. Testing & Commissioning

Testing should meet the Territorial Authority requirements. Prior to testing, seal all openings in the pipeline below the top of the section being tested. It is Marley's recommendation that all pipelines be tested before placing backfill in the trench. Conventional test plugs are suitable, provided the rubbers are in good condition.

### 6.1 Hydrostatic Testing Method

Fill the pipeline with water so a maximum height of no more than 6m is applied to the lowest end of the pipe section under test.

With drains, the line must be filled to no less than 1.5 metres above the natural ground level at the highest point.

Each joint shall be carefully examined for leaks. The pressure shall be held for at least 15 minutes.

The pipeline system passes a test if the visual inspection shows no evidence of leaks.

Maximum permissible volume of makeup water

Nominal Pipe Diameter	Maximum permissible makeup water per 100m of pipe (litres)
100	1.5
150	2.25
175	2.9
250	3.6
315	4.5
375	7.2

### 6.2 Air Test Method

Pump air into the fully sealed pipe system until the air pressure differential of 300mm of water registers on a suitable water manometer.

Disconnect the air supply and observe the gauge for 5 minutes.

If the pipeline will not hold pressure, visually inspect all of the joints by pouring a soapy water solution over the joints to detect the leaking areas.

The pipeline is considered to have passed the test if the pressure drop in the pipeline does not exceed 50mm ( i.e. 300mm down to 250mm head ).

### 6.3 Infiltration

Marley PVC DWV lines will have no infiltration even under a higher ground water level, although allowance must be made for infiltration at manholes.

### 6.4 Vacuum Testing

A designer may require a "vacuum" test where the pipeline is installed near or below the water table level and there is a likelihood of infiltration. The designer will usually give explicit instructions for conducting this test.

## 7. Handling & Storage

---

### 7.1 Scope

Pipeline materials are often handled many times during the period between production and final installation. The precision with which PVC pipes are manufactured warrant the careful handling of the product at all times in order not to impair its properties or preclude its use.

### 7.2. General Principles

Careful handling procedures are intended not only to protect the pipe from damage and deformation but, additionally, to ensure the safety of both the installers and public.

Some of the basic physical properties of PVC pipes are:

- The pipe material is notch sensitive; therefore cuts and deep scratches must be avoided.
- The effects of very low temperatures or prolonged exposure to direct sunlight tend to embrittle the pipe material; therefore sensible protection is required during protracted storage periods and extra care is recommended during very cold conditions.

### 7.3 Unloading and Handling

Deliveries of bulk quantities of pipe will be packed in wooden crates. If possible, they should be unloaded and stored in these crates, using some form of lifting equipment such as a front end loader, forklift, or backhoe. Crates should be stacked timber upon timber so the crates take the load.

Single pipes in smaller diameters are mostly light enough to be unloaded one at a time by hand. Pipes should never be simply dropped off the truck, nor should they be dragged along the ground.

Bundles of pipe should preferably be lifted with webbing or synthetic slings. Chains, steel wire slings etc can also be used if rubber sleeved or suitably padded. Slings should be placed under and around the bundle, not the bundle frames or straps.

When a number of pipes are being carried together on the job, they should be held securely, so they are not damaged by rubbing together or rolling around.

To prevent bowing, the maximum overhang of pipes being carried should not be more than one metre. For maximum safety the pipes should be carried close to the ground.

### 7.4 Stacking & Storage

#### *Stacking individual pipes*

When unloading the pipes one at a time the following stacking procedure is advised:

The bottom layer of pipes should be laid on timber bearers at least 75mm wide, and spaced not more than 2 metres apart, centre to centre. The weight of the stack should not be taken by the sockets of the bottom pipe layer.

Pipes should be stacked with sockets alternating end for end so that pipe sockets do not bear on each other.

If the stack is more than two layers high, vertical side supports, not more than 3 metres apart should be used.

Pipe stacks should not be more than 1.5 metres high.

When using pyramid stacking the maximum height should not be more than one metre, and the bottom pipes should be chocked.

Pipes should be stacked to prevent bowing or twisting of the pipe, regardless of method used.

## 7. Handling & Storage

### Storage

Pipes should not be stored in direct sunlight for longer than twelve months without a hessian or similar cover. Black plastic should be avoided as it can create excessive heat build-up.

### Stringing

Laying the pipes along the line of the trench is known as stringing.

The following points should be observed:

- Sockets should face the direction in which work will be going
- Pipes should be unloaded on the opposite side of the trench to the soil
- Pipes should be placed at 6 metre intervals
- Sockets should be placed so that the flow enters the socket end of the pipe.
- The identification marketing strip should be laid uppermost to aid in identifying the pipe should it be uncovered at any time in the future.

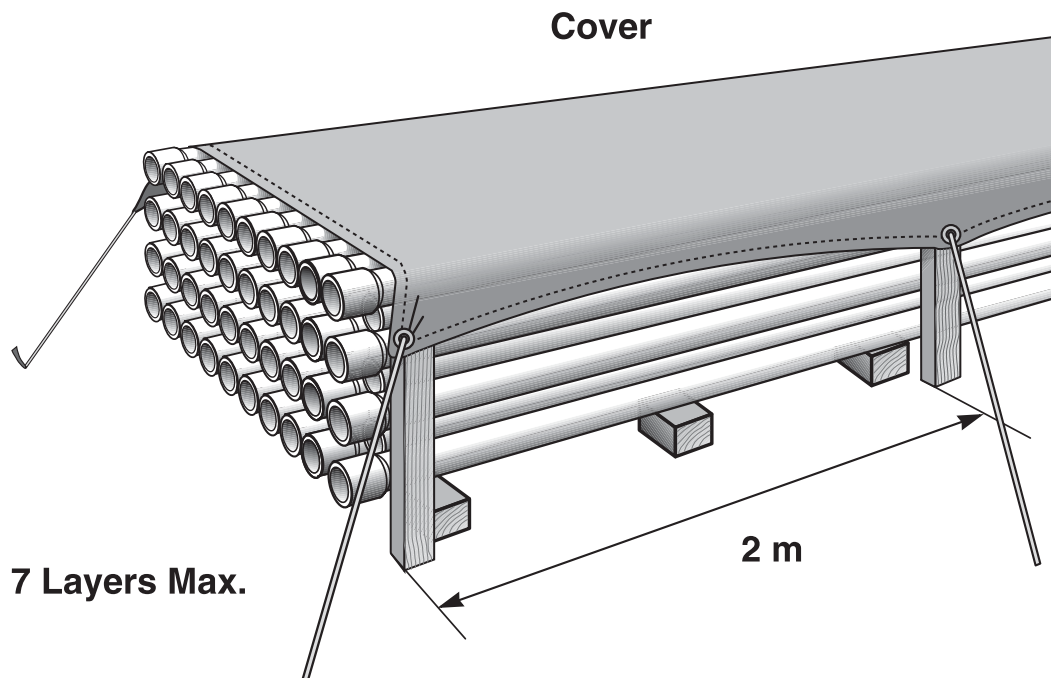

## 8. Jointing Procedures

### 8.1 Rubber Ring Jointing Procedure

Rubber ring seals are the most reliable and common joints used with PVC pipes. This method of jointing is achieved by either firm hand pressure or the use of a simple lever.

#### 8.1.1 Jointing Method

- Ensure the ring groove, rubber ring and spigot are clean. Insert the rubber ring with the sealing lip facing inwards and the ring evenly and fully housed in the groove.
- Check the chamfer, and the spigot mark on the pipe. If jointing a cut length of pipe, fully chamfer the pipe at 15° and mark the insertion line to give 12mm clearance from the pipe spigot bottoming in the socket. Clean and generously lubricate with Marley Pipe Jointing Lubricant, especially the chamfer. Do not lubricate the ring groove.
- Align the two pipes for both line and grade before insertion.
- Enter the spigot into the socket mouth, being careful not to introduce any dirt.
- Firmly push the pipe into the socket up to the insertion mark.

If excessive force is required to make the joint, disassemble and check the following:

- The ring is facing the correct direction.
- The ring and spigot are clean and have been lubricated.
- The ring and pipe spigot are correctly seated.
- If the pipe is pushed past the witness mark withdraw immediately; if the lubricant is left to dry it will be much more difficult to withdraw.
- To ensure an even grade, the bedding should be removed in the pipe socket area.
- Jointing may be assisted with a crow bar or shovel and a block of wood. Do not attempt to force the assembly. Machinery should only be used on larger pipe sizes, if necessary, and then only with extreme caution.
- The ring has not been dislodged and jammed (mouthed) on assembly.

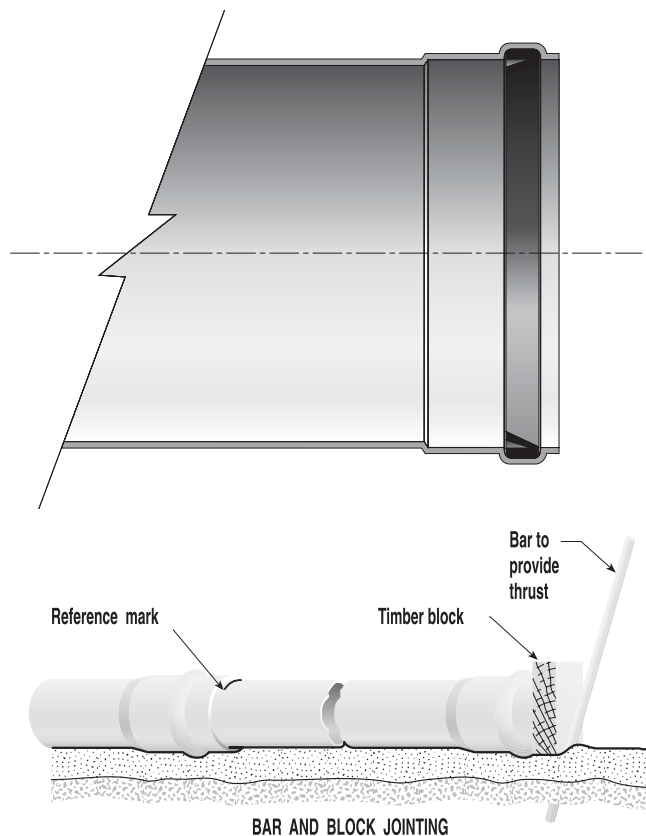

## 8. Jointing Procedures

---

### 8.2 Solvent Jointing Procedures

Assembly of solvent joints is easy, reliable and efficient as long as the following simple procedure is followed.

#### *Safety Precautions with Solvent Weld Jointing*

- Make sure there is adequate ventilation. Forced ventilation may be necessary inside buildings, in confined trenches and manholes.
- Solvent cement and priming fluids are highly flammable. Store them in a cool place away from heat, flames and sparks. Do not smoke while using them.
- Keep the containers tightly sealed when not in use.
- Do not add thinners or solvents to Marley Gold or Marley Primer.
- Do not use old solvent cement that has become jelly like or expired.
- Do not use dirty or contaminated brushes or rags.

Solvent cement spilt onto skin should be washed off immediately with soap and water. Should solvent cement affect the eyes, flush with cool clean water for at least 15 minutes. If solvent cement or primer is swallowed, induce vomiting. Safety and First Aid instructions on the container should be followed.

Wash hands thoroughly after use.

### 8.3 Special Considerations

Workmanship and correct procedures are essential for solvent joints if water tightness and durability are to be assured. Solvent jointing should only be carried out in dry conditions above 5°C, by appropriately trained personnel.

Solvent cement jointing is a welding not a gluing process. Priming fluid and Marley Gold soften the surfaces, so when they are brought together the two PVC surfaces bond together.

It is important that the spigot provides an interference fit in the socket. Do not attempt to make a joint that does not achieve an interference fit when dry. The actual area of contact between the spigot and the socket may only be a few millimetres. The spigot end must be square to make a good joint. Before proceeding, make sure that the spigots and sockets are not cracked or damaged.

**To make successful solvent weld joints on PVC pipe, the following procedure is recommended:**

- Minimise the number of joints.
- Introduce no deflections or strain on pipe fittings or joints.
- Check pipes have not been damaged during transit.
- Cut the pipes with only a fine tooth hack saw. Ensure the pipe spigot is cut square, taking care not to chip or crack the pipe. Remove all burrs from the inside. Make a 15° chamfer to the outside of the cut end of the pipe to remove any other burrs.
- Mark the insertion depth on the pipe spigot. The insertion depth is equivalent to the depth of the corresponding joint socket. The pipe should be marked with a soft pencil or felt pen which does not damage the pipe.
- Dry assemble all pipes and joints. Check that all joints have a full interference fit. Interference fit means that the pipe spigot should not be able to fully penetrate the socket up to the insertion mark without force.
- Mark the pipe and spigot for alignment by drawing a horizontal line across the joint with a soft pencil or felt pen.
- Ensure the pipe spigot and socket are free of dust, dirt and grease.

## 8. Jointing Procedures

- For pipe 50mm and over the surfaces should be lightly scuffed with clean 120 Emery cloth or sandpaper before priming. Prepare the pipe spigot and socket with Marley primer fluid using a cotton rag. Wipe the surfaces firmly, to remove all dirt and the glossy surface on both the spigot and socket. (Do not paint surfaces with primer. Primed areas will be slightly tacky.) Prime the surface just before applying the solvent.
- Apply an even coat of Marley Gold Solvent Cement to both the pipe spigot and socket. As a guide, the brush should be approximately one third to one half the pipe diameter and large enough to apply the solvent cement to both spigot and socket in about thirty seconds. Use Marley Gold PVC Solvent Cement which has not passed its use-by date. It is imperative that the solvent cement is in good condition. Old or contaminated cement should be carefully discarded in accordance with Local Body Regulations.
- The jointed surfaces must be softened (dissolved) and made semi-fluid by the cement.
- Sufficient cement must be applied to spigot and socket to fill the gap.
- Assembly of the pipe and fitting must be made while the surfaces are still wet and fluid.
- Hold the joint at the fully inserted position for 30 seconds. Pipes 100DN and larger may need to be mechanically inserted and held as the solvent bonds.
- Do not flex or disturb the joint for a further 15 minutes and handle with extreme care for at least another hour.
- Use sufficient cement to fill gaps and wipe off the excess solvent cement from the outside of the joint and, where possible, from the inside. Ensure excessive solvent is not left in the pipe or joint.
- Do not pressure test for 10 hours, to allow the solvent cement to dry. This will make sure that the joint is as strong as the rest of the pipe.

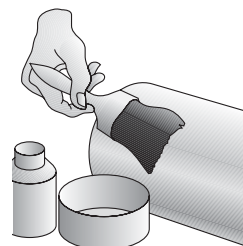

### 8.4 Testing

The NZ Building Code Approved Document G12/AS1 and G13 requires all pipe systems to be tested for water tightness irrespective of whether rubber ring joints or solvent cement joints are used. The testing procedures for Marley PVC, as detailed in section 6, should be followed. Testing should be done prior to backfilling and, where required, in the presence of a building officer from the Territorial Authority. Adequate notice should be given to the Territorial Authority before covering up the pipe system and, when required, before testing.

### 8.5 Jointing Material Normal Consumption

#### Consumption on Joints Per Litre

Nominal Size	Marley Priming Fluid	Marley Gold Solvent Cement	Joint Lubrication
40	500	120	
50	300	80	
65	250	70	
80	200	60	
100	100	50	100
150	90	40	75
175			50
225			45
250			40
300			30
375			25

## 9. Hydraulic Design

---

### 9.1 Design Principles

Where pipe lines are flowing full under gravity conditions, the grade of the pipeline gives the predicted head loss per length. However, special attention should be given to entry and exit losses with structures such as manholes, as these may have a significant effect.

For pipes at full flow, flow capacity can be calculated using pipe diameter, length and pipe gradient using graphs in 9.3 and 9.4.

### 9.2 Sewerage Flows

The following data is based on the Colebrook-White formulas, which are now widely used throughout the world for hydraulic sanitary sewer pipe design.

- Q = Discharge m<sup>3</sup>/second
- D = Pipe Internal Diameter (m)
- g = Gravitational Acceleration (9.8m/s<sup>2</sup>)
- L = Pipe Length (m)
- H = Uniform Friction Head Loss (m)
- Ks = Colebrook-White roughness coefficient
  - 0.06 clean drain
  - 0.6 mature drain
  - 1.5 mature silted drain
- $\nu$  = Kinematic Viscosity of Water  $1.141 \times 10^{-6}$  m<sup>2</sup>/s
- i* = Hydraulic Gradient
- v = Velocity metres/sec

$$V = 2 \sqrt{2gDi} \text{ Log } \left[ \frac{Ks}{3.7D} + \frac{2.5\nu}{D\sqrt{2gDi}} \right]$$

The Colebrook-White transition equation incorporates the smooth turbulent and rough turbulent conditions for a smooth pipe. The first term in the brackets tends to be zero and the second term predominates.

*Notes:*

# 9. Hydraulic Design

## 9.3 Flow Performance Clean Sanitary Sewer

For the theoretical maximum flow condition that can be expected in the early life of a sanitary or stormwater drain with no grit or sliming a  $K_s$  of 0.06mm can be selected.

DWV SANITARY DRAINS

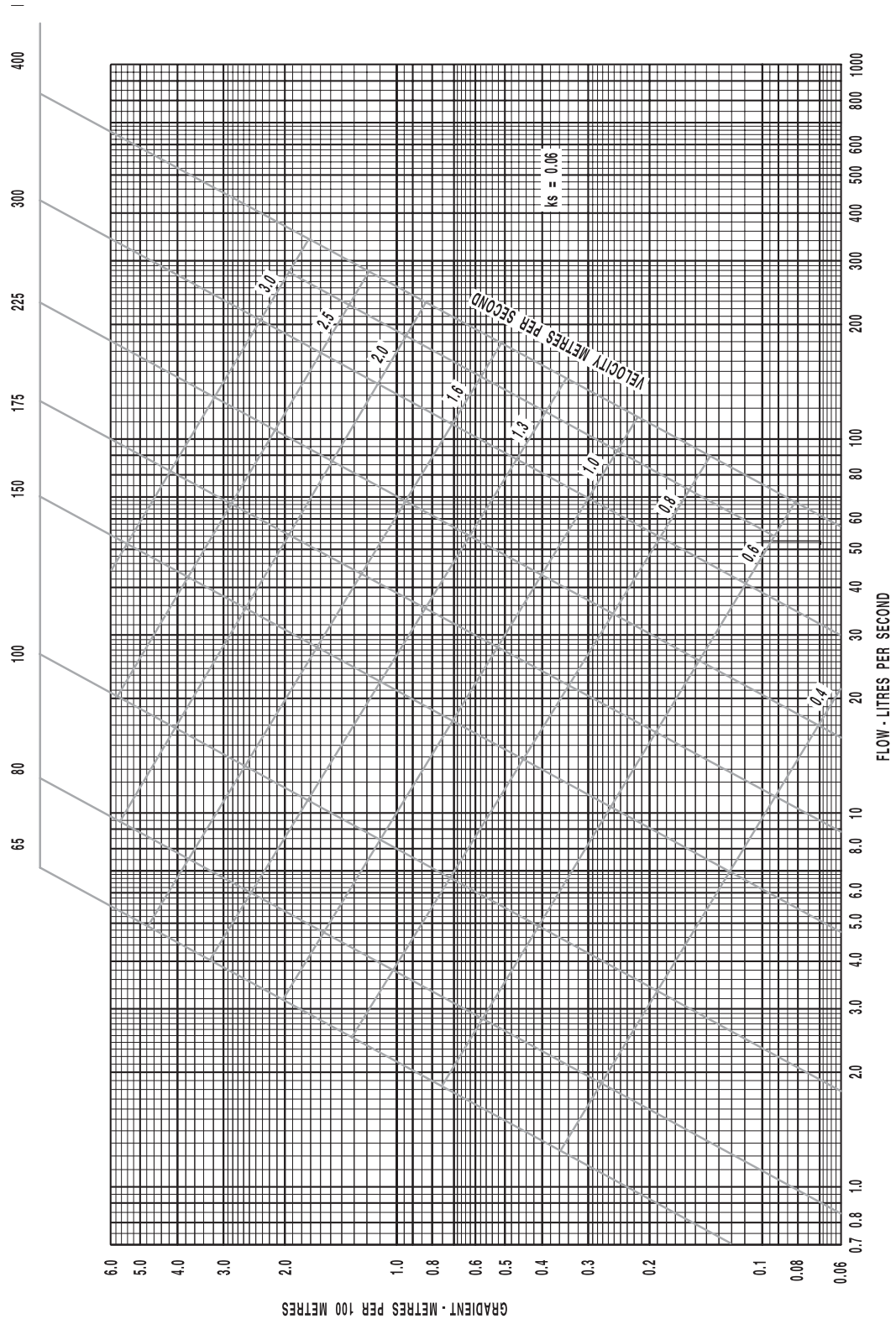



# 9. Hydraulic Design

## 9.4 Flow Performance Mature Sanitary Drains

With mature sewer drains a  $K_s$  of 0.6 and  $K_s$  of 1.5 should be considered.

This covers most service installations with predicted average slime growth and a little grit deposit.

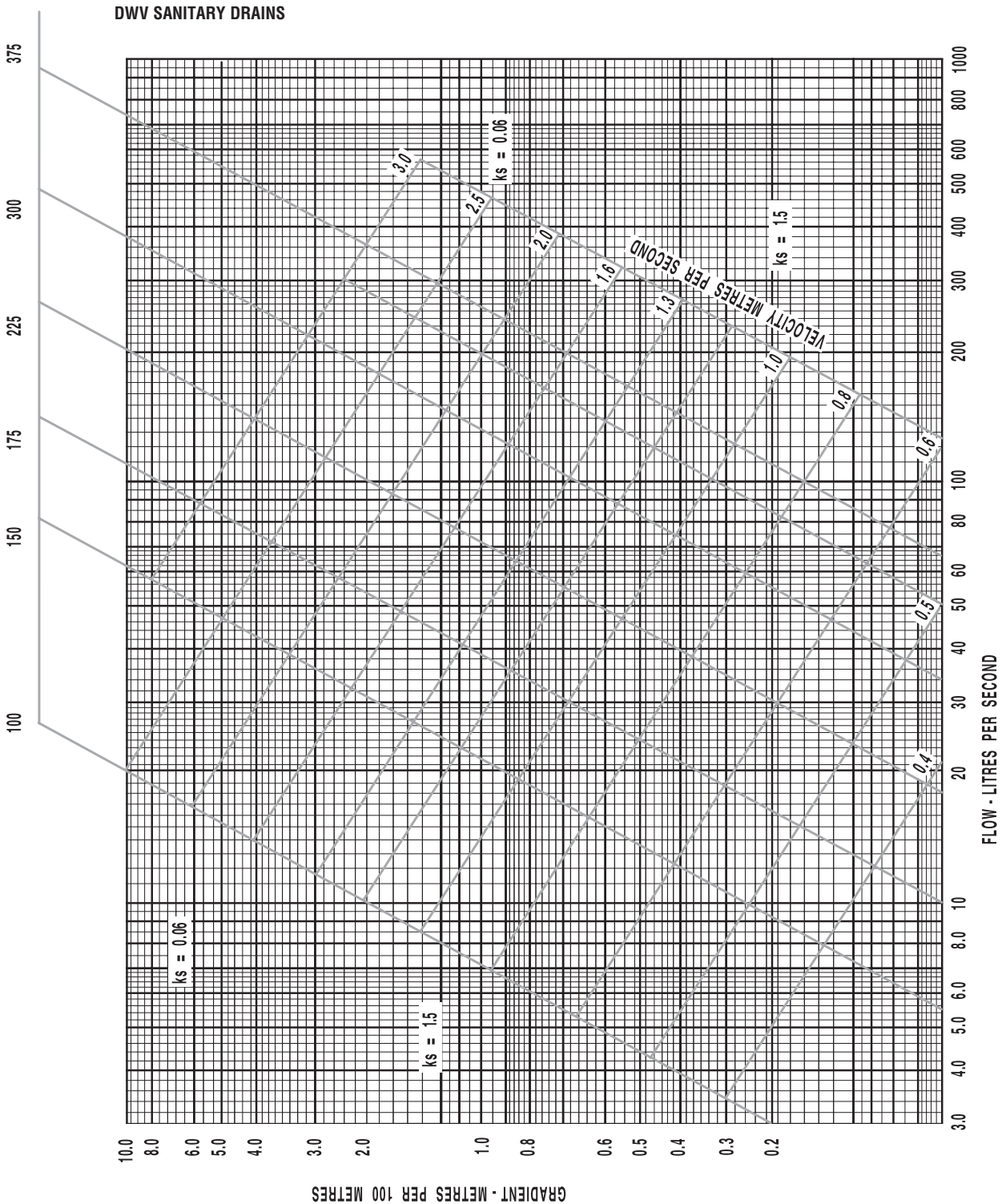

## 9. Hydraulic Design

### 9.5 Proportionate Value of Velocity

For value of  $K_s$  of 1.5mm with flow velocities below 1.0m/s. These values are combined on the below table.

Prop. Depth	Prop. Velocity	Prop. Discharge	Prop. Depth	Prop. Velocity	Prop. Discharge	Prop. Depth	Prop. Velocity	Prop. Discharge	Prop. Depth	Prop. Velocity	Prop. Discharge
0.01	0.089	0.000	0.26	0.716	0.148	0.51	1.008	0.517	0.76	1.135	0.925
0.02	0.140	0.000	0.27	0.732	0.159	0.52	1.016	0.534	0.77	1.136	0.939
0.03	0.183	0.001	0.28	0.747	0.171	0.53	1.024	0.551	0.78	1.138	0.952
0.04	0.222	0.003	0.29	0.761	0.183	0.54	1.031	0.568	0.79	1.139	0.965
0.05	0.256	0.004	0.30	0.776	0.195	0.55	1.039	0.585	0.80	1.139	0.977
0.06	0.289	0.009	0.31	0.790	0.208	0.56	1.046	0.603	0.81	1.140	0.989
0.07	0.319	0.009	0.32	0.803	0.221	0.57	1.053	0.620	0.82	1.139	1.000
0.08	0.348	0.013	0.33	0.817	0.235	0.58	1.059	0.637	0.83	1.139	1.011
0.09	0.375	0.016	0.34	0.830	0.248	0.59	1.066	0.654	0.84	1.138	1.021
0.10	0.401	0.020	0.35	0.843	0.262	0.60	1.072	0.671	0.85	1.137	1.030
0.11	0.426	0.025	0.36	0.855	0.277	0.61	1.078	0.688	0.86	1.135	1.039
0.12	0.450	0.030	0.37	0.867	0.291	0.62	1.083	0.762	0.87	1.133	1.047
0.13	0.473	0.036	0.38	0.879	0.306	0.63	1.089	0.722	0.88	1.131	1.054
0.14	0.495	0.042	0.39	0.890	0.321	0.64	1.094	0.739	0.89	1.128	1.060
0.15	0.516	0.048	0.40	0.902	0.337	0.65	1.099	0.756	0.90	1.124	1.065
0.16	0.537	0.055	0.41	0.913	0.352	0.66	1.103	0.773	0.91	1.120	1.070
0.17	0.557	0.062	0.42	0.923	0.368	0.67	1.108	0.789	0.92	1.115	1.073
0.18	0.577	0.070	0.43	0.934	0.384	0.68	1.112	0.805	0.93	1.109	1.075
0.19	0.596	0.078	0.44	0.944	0.400	0.69	1.116	0.821	0.94	1.102	1.075
0.20	0.615	0.087	0.45	0.954	0.416	0.70	1.119	0.837	0.95	1.095	1.074
0.21	0.633	0.096	0.46	0.964	0.433	0.71	1.123	0.852	0.96	1.085	1.071
0.22	0.650	0.106	0.47	0.973	0.449	0.72	1.126	0.868	0.97	1.075	1.065
0.23	0.667	0.116	0.48	0.982	0.466	0.73	1.128	0.882	0.98	1.061	1.056
0.24	0.684	0.126	0.49	0.991	0.483	0.74	1.131	0.897	0.99	1.034	1.041
0.25	0.700	0.137	0.50	1.000	0.500	0.75	1.133	0.911	1.00	1.000	1.000

### 9.6 Self-Cleaning Flow

The flow diagram is used to determine the dependence of gradient and flow rate, as well as the speed of the flow. For example, the diagram shows that flow rate  $Q = 20$  l/s and gradient at 5 per mille (5mm/m) require the use of  $d200$  mm pipe. The capacity of the pipeline will be  $Q_t = 25,5$  l/s and flow speed in a full pipe  $v_t = 0,9$  m/s. If the minimum flow in the pipeline is estimated at e.g. 5 l/s, the fill ratio is  $Q/Q_t = 5/25,5 = 0,2$ .

From the partial fill diagram we can see that with this ratio, the relative height of the water surface  $h/d_i = 0,3$ , the relative flow speed  $v/v_t = 0,81$  and relation of the hydraulic radii  $R/R_t = 0,72$ . Based on these relations, we can calculate the flow speed, the height of the water surface in the pipe, and the hydraulic radius. For calculating the latter two values, the inside diameter of the pipe is determined:  $d_{ID} = d_{OD} - 2 \times t$  ( $t$  = pipe wall thickness).

In our example  $d_i = 200 - 2 \times 4,9 = 190,2$  mm). Flow speed  $v = 0,81 \times 0,9 = 0,73$  m/s, Water height  $h = 0,3 \times 190,2 = 59$  mm, Hydraulic radius  $R = 0,72 \times 190,2/4 = 34,2$  mm.

The self-cleaning properties of the pipeline can be estimated by calculating the friction stress

from the formula  $T = \gamma \times g \times I \times R$  where

$T$  = friction stress  $N/m^2$ ,

$\gamma$  = density of water =  $1000kg/m^3$ ,

$g$  = acceleration at earth's gravity =  $9,81$   $m/s^2$ ,

$I$  = gradient  $m/m$ ,

$R$  = hydraulic radius  $m$ .

In our example, the friction stress is

$$T = 1000 \times 9,81 \times 0,005 \times 0,0342 = 1,68 \text{ N/m}^2.$$

According to various investigations, a sewer pipeline can be regarded as self-cleaning if its friction stress exceeds conservatively  $1.5 \text{ N/m}^2$ .

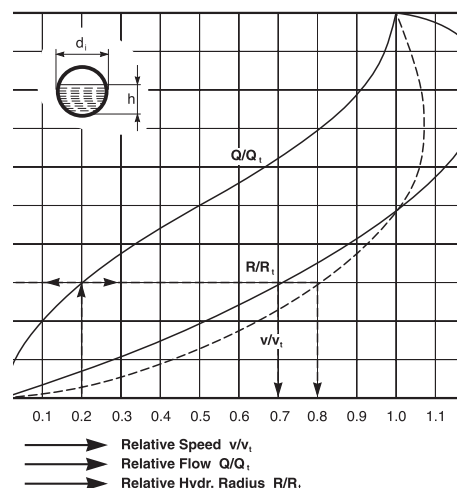

## 9. Hydraulic Design

### 9.7 Minimum Gradients for Sewers

The minimum gradient for gravity sewer pipelines should preferably not be flatter than the grade required to achieve a boundary shear of 1.5 Pa at least once a day. The boundary shear stress is also dependent on the minimum dry weather daily peak (MDWDP) flow, as well as the gradient of the pipeline.

As a general rule of thumb, the pipe grade should not be flatter than the reciprocal of the nominal pipe diameter. Where it is not possible to achieve this grade, slightly flatter grades can be used, but potentially may result in on-going maintenance costs. Where flat grades are necessary, serious consideration should be given to the need for plumbing or the use of flushing tanks to ensure that thorough flushing occurs periodically. For new development areas where the MDWDP may be lower than necessary to achieve a flushing flow most days, it may be temporarily necessary to carry out flushing.

The traditional minimum gradient values used for concrete and ceramic sewer pipelines are conservative for smooth bore plastics and experience has shown that flatter grades can be used with confidence. There is some evidence that if the boundary shear stress is 1.0 Pa or higher, the pipeline will still be self-cleansing, but grades this flat should be avoided if possible.

Very flat grades should be avoided due to the difficulty in ensuring that a continuous fall is maintained. Small misalignments in installation or those caused by settlement of bedding can easily result in areas of “ponding” in the pipeline and potential blockage.

*The following table provides some guidance in selection of extreme minimum gradients for sewer pipeline design.*

Pipe DN (mm)	Rule of Thumb min. grade	Min Unflushed Grade	MDWDP (L/s)	Min Flushed Grade	Flushing Flow (L/s)
100	0.01	0.01	-	-	-
150	0.00667	-	-	0.003	9
150	-	0.006	1.0	-	-
150	-	0.005	1.5	-	-
150	-	0.004	202	-	-
175	0.0053	-	-	0.0025	13
175	-	0.005	105	-	-
175	-	0.004	2.2	-	-
175	-	0.003	3.5	-	-
225	0.0043	-	-	0.002	20
225	-	0.005	1.8	-	-
225	-	0.004	2.4	-	-
225	-	0.003	4.0	-	-
300	0.0034	-	-	0.0015	34
300	-	0.003	4.5	-	-
300	-	0.002	6.6	-	-

As a general rule, the volume of flushing water should be sufficient to completely fill the main along the section of flat gradient. The connection from the flushing tank to the manhole must be capable of carrying the flushing flow as shown in the table. Appropriate backflow prevention should be provided on the water supply connection to the flushing tank.

The frequency of the flushing and the possible need for periodic swabbing or water jetting will depend on the actual grade and the duration and magnitude of peak flows and can only be determined from experience.

### 9.8 Rising Pressure Mains

Head loss calculation should be based on  $K_s = 0.6\text{mm}$  as pump velocities invariably exceed 1.0m/s. Pumping performance should be checked against minimum head loss as surface slime growth will be slow or insignificant.

# 10. Structural Design Performance

## 10.1 Deflection Limits

PVC pipe systems are referred to as flexible pipe systems, meaning they can deflect under external load without distress.

This unique ability to deflect under load ensures that when soil and ground movement takes place, (eg. soil consolidation in the first 3 years after installation, earth movement and earthquakes), the PVC pipe line integrity should be maintained.

Marley Optim, Spectrum and Quantum are not designed for pressure pipe performance, but for their stiffness characteristic, and their ability to withstand external soil and live loads.

Marley Impact is designed to have both a pressure performance as a rising or pumping main, with high resistance to notch growth from handling or long term stress from bedding, along with good crush resistance.

Deflection in flexible pipes is resisted by the passive soil support from the soil surrounding the pipe, the trench, the pipe class/rating and the compaction of the bedding material. All must be considered when providing a performance statement on the pipe.

$$\text{Pipe Deflection} = \frac{\text{Total Load on a pipe}}{\text{Pipe Stiffness} + \text{Soil Stiffness}}$$

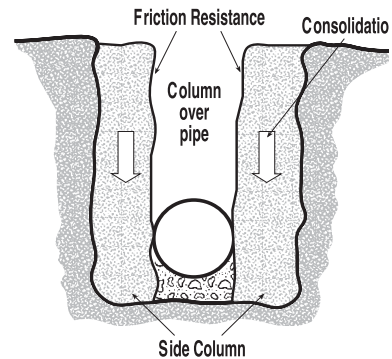

Design limits commonly used for deflection of a pipe system are 5% for short term and 7.5% for long-term (50 years). These figures ensure that the flow characteristics of the pipe are not compromised, and that the integrity of all the joints is maintained.

Deflection data collected from studies over the last 30 years show deflection is related to soil movement in the first few years. For the rest of the pipe system's life, the movement is negligible in any well installed PVC pipe system.

It is assumed that the installers will be competent and install the pipe in line with recommended procedures and to specification.

The following graph is taken from the Recorded Research Data showing clearly old, thinner wall pipe with higher a (51), although adequate, will have greater ovality over time than current lower SDR pipe systems. But with all piping materials the SDR and E modulus of the pipe material must be factored into the deflection design requirements.

While not recommended, there are many PVC pipelines that are performing satisfactorily with deflections up to 20%. Such excessive deflection may be caused by poor compaction of side support or by migration of the bedding material into the surrounding soil.

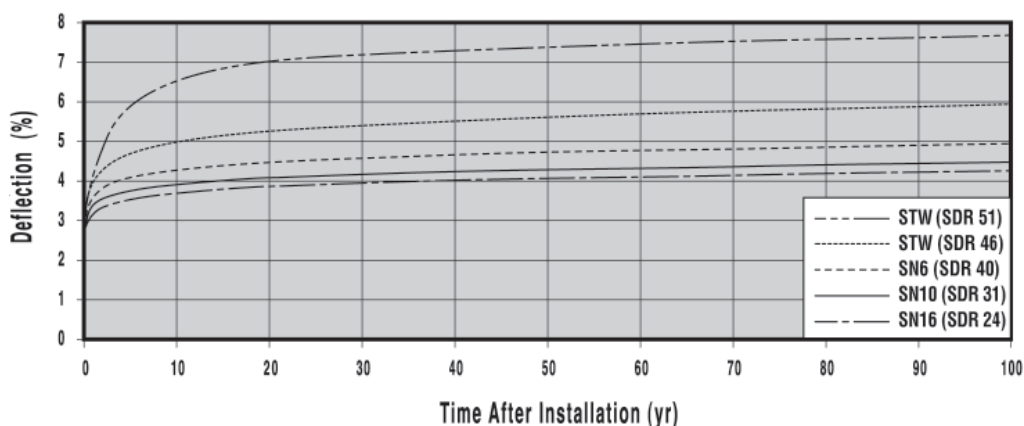

# 10. Structural Design Performance

## 10.2 Embedment Geometry

Embedment width, bedding and overlay - the width requirements are listed in the following table.

Nominal Pipe Size	Bedding Minimum Values mm		
		Min Bed Depth	Side Cover Min
<b>Cover</b>			
DN 75 ≥ ≤150	75	DN + 200mm	100
DN 150 > ≤300	100	DN + 200mm	150
DN 300 > ≤450	100	DN + 200mm	150

## 10.3 Foundation

Any over-excavation of the foundation shall be filled, using, where possible, the same material to be used for the embedment, and compacted to achieve a modulus equivalent of the embedment material.

## 10.4 Support Systems (Shoring)

When trench support systems are used, embedment material shall be placed and compacted, so that no loss of compaction results from removal of the trench side support systems.

The trench support shall be removed in such a way as to ensure that the placing and compaction of embedment material occurs below such trench support systems and against the undisturbed native soil trench walls.

## 10.5 Compaction

Embedment material shall be placed in a manner to ensure uniformity of density of the side support, including the haunch support, and overlay with no distortion, dislodgment or damage to the pipeline. Where required to be compacted, embedment material shall be placed in layers of thickness suitable for the method of compaction to achieve the specified density uniformly throughout. Usually, 450mm layers are adequate.

## 10.6 Soil Moduli

**Native soil modulus** - The native soil modulus ( $E'_n$ ) for different materials and degrees of compaction are given in the following table in MPa

Native soil is assumed to be the material present to a distance 2.5D (zone of influence for side support) from the centre-line of the pipeline.

**Effective combined soil modulus** - The effective combined soil modulus of the embedment ( $E'$ ) is calculated:  $E' = \zeta E_n$

# 10. Structural Design Performance

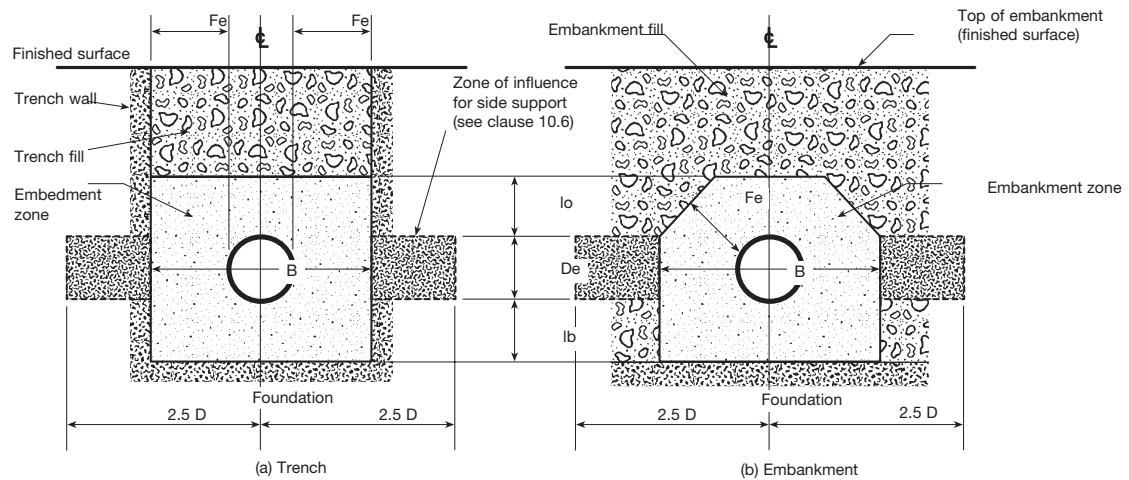

## Embedment and Soil - Material Moduli

Native Soil	Standard Soil Compaction	Soil Type AS1726S	$E^N$	91%	92%	95%	97%
			MPa	7§	7§	10§	14
Gravel - single size		-					
Gravel - graded		GW	9	5§	7§	10§	20
Sand and coarse-grained soil with less than 12% fines		GP, SW, SP & GM-GL, GC-SC etc	4	3§	5§	7§	14
Coarse-grained soil with more than 12% fines		GM, GC, SC SM & GM-SC, GC-SC		1§	3§	5§	10
Fine-grained soil (LL<50%) with medium to no plasticity and containing more than 25% coarse-grained particles		CM, ML, mixtures ML-CL, CL-CH & ML-MH	2	1§	3§	5§	10
Fine-grained soil (LL<50%) with medium to no plasticity and containing less than 25% coarse-grained particles		Cl, CL, ML mixtures ML-CL CL-CH & ML-MH	1	NR	1	3	7
Fine-grained soil (LL>50%) with medium to high plasticity		CH, MH & CH-MH	0.5	NR	NR	NR	NR

§ Value Commonly Achieved in Practise

### 10.7 Deflection Prediction

Deflection in flexible pipe systems can be predicted using the Modified Spangler Formula to take into account different loading conditions for the specific pipe material performances.

The E Modulus that is used to determine any long-term performance must relate to the specific pipe material class and rating, as the different constructions offer different long term performances.

### 10.8 Design of PVC Pipelines

The modified Spangler formula can be written as:

$$\Delta y = \frac{D \times K \times 10^{-3} (W^D + W^I)}{8 \times 10^{-6} S_{DL} + 0.061E^1}$$

# 10. Structural Design Performance

- Where:  $\Delta y$  = change in diameter (mm)  
 W = loads on pipe related to soil ( $W^D$ ) or traffic  $W^D$  or live loads  $W_1$  (kN/m)  
 K = bedding deflection co-efficient is assumed to be 0.1 unless detailed engineering calculations show otherwise  
 D = Diameter at neutral axis of pipe wall  
 E' = Effect Combination of the soil modulus MPa

$$S_{DL} = \frac{E_{bl} \times I}{D^3} \times 10^6$$

- Where: E = Youngs modulus (MPa) for the PVC construction material used in the pipe (refer section 3).  
 I = Moment of inertia of the pipe wall  
     =  $t^3/12$  (mm<sup>3</sup>)  
 t = wall thickness (mm)  
 r = mean pipe radius (mm)  
 D = Diameter of neutral sizes of pipe wall.

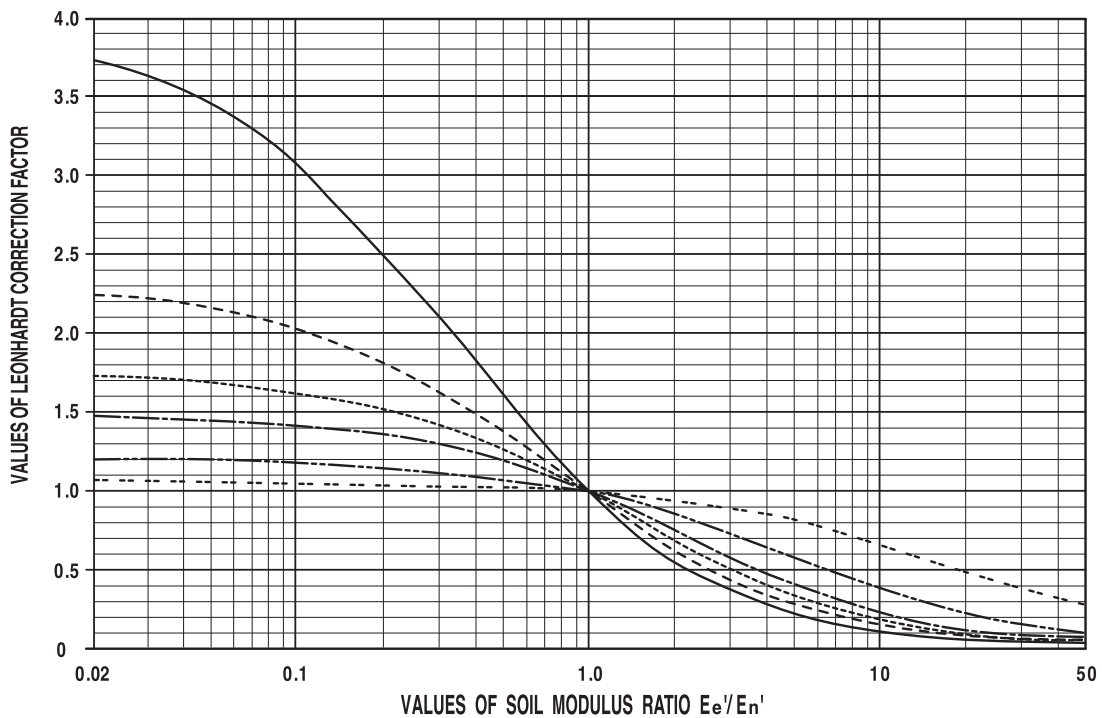

- B/D = 1.5      —————
- B/D = 2.0      - - - - -
- B/D = 2.5      - - - - -
- B/D = 3.0      - - - - -
- B/D = 4.0      - - - - -
- B/D = 5.0      - - - - -





# 10. Structural Design Performance

## 10.9 Maximum Buried Depth

Based on 5% Long Term deflection pipe performance for soil and embedment.

Native Soil	$E_N$	Cover Depth (m)	$E_e = \text{Compaction Narrow Trench}$			
			97%	95%	92%	90%
Very Stable	$E_e' = 9 \text{ MP}_A$	2				
		4				
		6				
		8				
		10				
		12				
Stable Soils	$E_e' = 4 \text{ MP}_A$	2				
		4				
		6				
		8				
		10				
		12				
Soil Mixture Medium Cohesive and Loose Granular	$E_e' = 2 \text{ MP}_A$	2				
		4				
		6				
		8				
		10				
Cohesive Soils Soft to very loose	$E_e' = 0.5 \text{ MP}_A$	2				
		4				
		6				
		8				

	Class SN10 80 kN wheel loading
	Class SN16 80 kN wheel loading
	Class SN10 35 kN wheel loading
	Class SN16 35 kN wheel loading

## 10.10 Soil Load

The method of calculating the soil load on a flexible pipe is simply to take it as the weight of the column of soil above the pipe. This is called the “prism load” and is determined from the volume of soil above a metre length of pipe multiplied by the specific weight.

$$W_b = \rho g D H$$

Where:  $W$  = load per unit length on the pipe (N/m)

$\rho$  = soil density ( $\text{kg/m}^3$ )

$D$  = pipe diameter (m)

$H$  = Cover height (m)



## 10. Structural Design Performance

---

Using the prism load is particularly conservative for flexible pipe laid in narrow trenches, as it ignores the friction effects both of the columns of soil adjacent to the column over the pipe, and against the trench walls. These friction effects significantly reduce the load on the pipe.

### Superimposed Live Loads Road Vehicles

For shallow pipes, the live load ( $W_1$ ) becomes significant and can be determined (also refer to AS2566 charts). The average intensity of the design live load at the top of a pipe due to multiple wheel or track vehicle loads, including impact effects, is calculated from the following equation:

$$W_1 = \frac{\sum P}{L_1 L_2} \alpha$$

Where:

$W_1$  = Vertical design load kPA

$\sum P$  = Sum of individual wheel loads kN

$L_1$  = Length of the base of the live load (m) measure perpendicular to the direction of travel of the vehicle at the top.

$\alpha$  = Live load impact factor  
(1.4 - 0.15H but not less than 1.1)

NOTES:

# 11. Chemical Resistance

Three different classes of chemical resistance degree are conventionally used in this guide ie:

**Class 1: HIGH RESISTANCE** (corrosion-proof) - all materials belonging to this class are completely or almost completely corrosion-proof against the conveyed fluid, according to the specified operating conditions.

**Class 2: LIMITED RESISTANCE** - the materials belonging to this class are partially attacked by the conveyed chemical compound. The average life of the material is therefore shorter, and it is advisable to use a higher safety factor by selecting a higher SN rating pipe.

**Class 3: NO RESISTANCE** - all material belonging to this class are subject to corrosion by the conveyed fluid and they should therefore not be used.

The absence of any class indication means that no data are available concerning the chemical resistance of the material in respect of the conveyed fluid.

## ABBREVIATIONS

*sat* = saturated solution at 20°C, *nd* = undefined concentration, *deb* = weak concentration, *comm* = commercial solution. *dil* = diluted solution

	FORMULA	CONC %	TEMP (°C)	PVC	PE		FORMULA	CONC %	TEMP (°C)	PVC	PE	
ACETALDEHYDE	CH <sub>3</sub> CHO	100	25 60	3 3	1	- FLUORIDE - HYDROXIDE - NITRATE - PHOSPHATE DIBASIC - PHOSPHAT META - PHOSPHATE TRI - PERSULFATE - SULFIDE - SULFHYDRATE	NH <sub>4</sub> F	25	25 60	1 2	1 1	
- AQUEOUS SOLUTION		40	25 60	3 3	1 2		NH <sub>4</sub> OH	28	25 60	- 2	1 1	
ACETIC ACID	CH <sub>3</sub> COOH	≤ 25	25 60	1 2	1 1		NH <sub>4</sub> NO <sub>3</sub>	sat	25 60	1 1	1 1	
		30	25 60	1 2	1 1		NH <sub>4</sub> (HPO <sub>4</sub> ) <sub>2</sub>	all	25 60	1 1	1 1	
		60	25 60	1 2	1 1		(NH <sub>4</sub> ) <sub>4</sub> P <sub>4</sub> O <sub>12</sub>	all	25 60	1 1		
- GLACIAL		100	25 60	2 3	1 2		(NH <sub>4</sub> ) <sub>2</sub> HPO <sub>4</sub>	all	25 60	1 1		
ACETIC ANHYDRIDE	(CH <sub>3</sub> CO) <sub>2</sub> O	100	25 60	3 3	2 2		(NH <sub>4</sub> ) <sub>2</sub> S <sub>2</sub> O <sub>8</sub>	all	25 60	1 1		
ACETONE (DIMETHYL KETONE)	CH <sub>3</sub> COCH <sub>3</sub>	10	25 60	3 3	1 1		(NH <sub>4</sub> ) <sub>2</sub> S	deb	25 60	1 2	1 1	
		100	25 60	3 3	2 2		sat	25 60	1 1	1 1	1 1	
ACETOPHENONE (ACETYL BENZENE OR PHENYL METHYL KETONE)	CH <sub>3</sub> COC <sub>6</sub> H <sub>5</sub>	nd	25 60				NH <sub>4</sub> OHSO <sub>4</sub>	dil	25 60	1 2	1 1	
						sat	25 60	1 1	1 1	1 1		
ACRYLONITRILE (ACRYLONITRILE OR VINYL CYANIDE)	CH <sub>2</sub> CHCN	technically pure	25 60	3	1	AMYACETATE (PENTYL ACETATE)	CH <sub>3</sub> CO <sub>2</sub> CH <sub>2</sub> (CH <sub>2</sub> ) <sub>3</sub> CH <sub>3</sub>	100	25 60	3 3	1 2	
ADIPIC ACID AQUEOUS SOLUTION	(CH <sub>2</sub> CH <sub>2</sub> CO <sub>2</sub> H) <sub>2</sub>	sat.	25 60	1 2	1 1	AMYLALCOHOL	CH <sub>3</sub> (CH <sub>2</sub> ) <sub>3</sub> CH <sub>2</sub> OH	nd	25 60	1 2	1 1	
ALLYL ALCOHOL	CH <sub>2</sub> CHCH <sub>2</sub> OH	96	25 60	2 3	1 2	ALNILINE (PHENYLAMINE OR AMINOBENZENE) - CHLORHYDRATE (ANILINE HYDROCHLORIDE)	C <sub>6</sub> H <sub>5</sub> NH <sub>2</sub>	all	25 60	3 3	2 2	
ALUM AQUEOUS SOLUTION (POTASH ALUM.SOL.)	Al <sub>2</sub> (SO <sub>4</sub> ) <sub>3</sub> K <sub>2</sub> SO <sub>4</sub> ·H <sub>2</sub> O	dil dil sat.	25 60 60	1 2 2	1 1 1	ANTIMONY - TRICHLORIDE	SbCl <sub>3</sub>	100	25 60	1 1	1 1	
ALUMINIUM - CHLORIDE - FLORIDE - HYDROXIDE	AlCl <sub>3</sub>	all	25 60	1 1	1 1	ANTHRAQUINONE (SULFONIC ACID)	suspension	25	1 60	1 2	1 -	
	AlF <sub>3</sub>	100	25 60	1 1	1 1	AQUA REGIA	HCl+HNO <sub>3</sub>	100	25 60	2 2	3 3	
	Al(OH) <sub>3</sub>	all	25 60	1 1	-	ARSENIC ACID	H <sub>3</sub> ASO <sub>4</sub>	deb	25 60	1 2	1 1	
NITRATE	Al(NO <sub>2</sub> ) <sub>3</sub>	nd	25 60	1 1	-		80	25 60	1 2	1 1		
SULFATE	Al(SO <sub>4</sub> ) <sub>3</sub>	deb	25 60	1 1	1	BARIUM CARBONATE - CHLORIDE	BACO <sub>3</sub>	all	25 60	1 1	1 1	
		sat	25 60	1 1	1		BaCl <sub>2</sub>	10	25 60	1 1	1 1	
AMMONIA - AQUEOUS SOLUTION	NH <sub>3</sub>	deb	25 60	1 2	1 1	- HYDROXIDE	Ba(OH) <sub>2</sub>	all	25 60	1 1	1 1	
		sat	25 60	1 2		- SULFATE	BaSO <sub>4</sub>	rib	25 60	1 1	1 1	
- DRY GAS		100	25 60	1 1	1 1	- SULFIDE	BaS	sat	25 60	1 1		
- LIQUID		100	25 60	2 3	1 1	BEER		comm	25 60	1 1	1 1	
AMMONIUM - ACETATE - CARBONATE	CH <sub>3</sub> COONH <sub>4</sub>	sat	25 60	- 2	1 1	BENZALDEHYDE	C <sub>6</sub> H <sub>5</sub> CHO	nd	25 60	3 3	2 2	
	(NH <sub>4</sub> ) <sub>2</sub> CO <sub>3</sub>	all	25 60	1 2	1 1							

# 11. Chemical Resistance

	FORMULA	CONC %	TEMP (°C)	PVC	PE		FORMULA	CONC %	TEMP (°C)	PVC	PE
BENZENE (BENZOL)	C <sub>6</sub> H <sub>6</sub>	100	25 60	3 3	3	CHLORAMINE	NH <sub>2</sub> Cl	dil	25 60	1 1	1
- + LIGROIN		20/80	25 60	3 3		CHLORIC ACID	HClO <sub>3</sub>	20	25 60	1 2	1 3
- MONOCHLORINE	C <sub>6</sub> H <sub>5</sub> Cl	technically pure	25 60	3 3	2	CHLORINE	Cl <sub>2</sub>	sat	25 60	2 3	
BENZOIC ACID	C <sub>6</sub> H <sub>5</sub> COOH	sat	25 60	1 2	1 1	- DRY GAS		10 100	25 60 25 60	1 2 2 3	
BENZYL ALCOHOL	C <sub>6</sub> H <sub>5</sub> CH <sub>2</sub> OH	100	25 60	1 2		- WET GAS		5 g/m3 10 g/m3 66 g/m3	25 60 25 60 25 60	1 3 2 2 2	
BORIC ACID (BORACIC ACID)	H <sub>3</sub> BO <sub>3</sub>	deb sat	25 60 25 60	1 2 1 2	1 1 1 1	- LIQUID		100	25 60	3 3	3 3
BRINE		comm	25 60	1 1		CHLOROACETIC ACID	ClCH <sub>2</sub> COH	85 100	25 60 25 60	1 2 3 3	2 3 3 3
BROMIC ACID	HBrO <sub>3</sub>	10	25 60	1 1	1	CHLOROBENZENE	C <sub>6</sub> H <sub>5</sub> Cl	all	25 60	3 3	
BROMINE - LIQUID - VAPOURS	Br <sub>2</sub>	100	25 60	3 3	3	CHLOROFORM	CHCl <sub>3</sub>	all	25 60	3 3	2
BUTADIENE	C <sub>4</sub> H <sub>6</sub>	100	25 60	1 1	3	CHLOROSULPHONIC ACID	ClHSO <sub>3</sub>	100	25 60	2 3	3 3
BUTANEDIOL AQUEOUS	CH <sub>3</sub> CH <sub>2</sub> CHOHCH <sub>2</sub> OH	10 concentrated	25 60 25 60	1 3 2 3	2 3	CHROME ALUM	KCr(SO <sub>4</sub> ) <sub>2</sub>	nd	25 60	1 2	1 1
BUTANE GAS	C <sub>4</sub> H <sub>10</sub>	10	25 60	1 1	1	CHROMIC ACID	CrO <sub>3</sub> +H <sub>2</sub> O	10 30 50	25 60 25 60 25 60	1 2 1 2 2 3	2 3 2 3 2 3
BUTYL - ACETATE (BUTANATE) - ALCOHOL (BUTANOL) - PHENOL	CH <sub>3</sub> CO <sub>2</sub> CH <sub>2</sub> CH <sub>2</sub> CH <sub>2</sub> CH <sub>3</sub> C <sub>4</sub> H <sub>9</sub> OH C <sub>4</sub> H <sub>9</sub> C <sub>6</sub> H <sub>4</sub> OH	100	25 60	3 3	3	CHROMIC SOLUTION	CrO <sub>3</sub> +H <sub>2</sub> O+H <sub>2</sub> SO <sub>4</sub>	50/35/15	25 60	1 3	2 3
BUTYLENE GLYCOL	C <sub>4</sub> H <sub>6</sub> (OH) <sub>2</sub>	100	25 60	2 2	1	CITRIC ACID AQUEOUS SOLUTION	C <sub>3</sub> H <sub>4</sub> (OH)(CO <sub>2</sub> H) <sub>3</sub>	50	25 60	1 1	1 1
BUTYRIC ACID (BUTANOIC ACID)	C <sub>2</sub> H <sub>5</sub> CH <sub>2</sub> COOH	20 concentrated	25 60 25 60	1 2 3 3	1 2 3 3	COPPER - CHLORIDE	CuCl <sub>2</sub>	sat	25 60	1 1	1 1
CALCIUM - BISULFITE - CARBONATE	Ca(HSO <sub>3</sub> ) <sub>2</sub> CaCO <sub>3</sub>	nd all	25 60	1 1	1 1	- CYANIDE	CuCN <sub>2</sub>	all	25 60	3 3	
- CHLORATE	CaHCl	nd	25 60	1 1	1 1	- FLUORIDE	CuF <sub>2</sub>	all	25 60	1 1	1 1
- CHLORIDE	CaCl <sub>2</sub>	all	25 60	1 2	1 1	- NITRATE	Cu(NO <sub>3</sub> ) <sub>2</sub>	nd	25 60	1 2	1 1
- HYDROXIDE	Ca(OH) <sub>2</sub>	all	25 60	1 1		- SULFATE	CuSO <sub>4</sub>	dil sat	25 60 25 60	1 1 1 1	1 1 1 1
- HYPOCHLORITE	Ca(OH) <sub>2</sub>	sat	25 60	1 2	1	COTTONSEED OIL		comm	25 60	1 1	
- NITRATE	Ca(NO <sub>3</sub> ) <sub>2</sub>	50	25 60	1 1	1	CRESOL (HYDROXY TOLUENE)	CH <sub>3</sub> C <sub>6</sub> H <sub>4</sub> OH	≤90 ≥90	25 60 25 60	2 3 3 3	1
- SULFATE	CaSO <sub>4</sub>	nd	25 60	1 1	1	CRESYLIC ACID	CH <sub>3</sub> CH <sub>6</sub> H <sub>4</sub> COOH	50	25 60	2 3	
- SULFIDE	CaS	sat	25 60	1 2	2	CYCLOHEXANE	C <sub>6</sub> H <sub>12</sub>	all	25 60	3 3	1
CAMPOR OIL		nd	25 60	1 3	3	CYCLOHEXANONE	C <sub>6</sub> H <sub>10</sub> O	all	25 60	3 3	1
CARBON - DIOXIDE AQUEOUS SOLUTION - GAS	CO <sub>2</sub>	-	25 60	1 2	1	DECAHYDRONAPHTALENE	C <sub>10</sub> H <sub>18</sub>	nd	25 60	1 1	1 2
- DISULFIDE	CS <sub>2</sub>	100	25 60	1 2	1	DEMINERALIZED WATER		100	25 60	1 1	1 1
- MONOXIDE	CO	100	25 60	1 1	1	DIBUTYPHTHALATE	C <sub>6</sub> H <sub>4</sub> (CO <sub>2</sub> C <sub>4</sub> H <sub>9</sub> ) <sub>2</sub>	100	25 60	3 3	3
- TETRACHLORIDE	CCl <sub>4</sub>	100	25 60	2 3	2 3	DICHLORO-ACETIC ACID	Cl <sub>2</sub> CHCOOH	100	25 60	1 2	1 1
CARBONIC ACID - AQUEOUS SOLUTION - DRY - WET	H <sub>2</sub> CO <sub>3</sub>	sat 100 all	25 60 25 60	1 1 1 2	1 1 1 1	DICHLOROETHANE (ETHYLENE DICHLORIDE)	CH <sub>2</sub> ClCH <sub>2</sub> Cl	100	25 60	3 3	3 3
CARBON OIL		comm	25 60	1 1		DICHLOROETHYLENE	Cl(CH <sub>2</sub> ) <sub>2</sub> Cl	100	25 60	3 3	3 3
						DIETHYL ETHER	C <sub>2</sub> H <sub>5</sub> OC <sub>2</sub> H <sub>5</sub>	100	25 60	3 3	3 3
						DIGLYCOLIC ACID	(CH <sub>2</sub> ) <sub>2</sub> O(CO <sub>2</sub> H) <sub>2</sub>	18	25 60	1 2	1 1
						DIMETHYLAMINE	(CH <sub>3</sub> ) <sub>2</sub> NH	100	25 60	2 2	2 2

# 11. Chemical Resistance

	FORMULA	CONC %	TEMP (°C)	PVC	PE		FORMULA	CONC %	TEMP (°C)	PVC	PE		
DIOCTYLPHTHALATE		all	25 60	3 3	1 2	HYDROCHLORIC ACID (MURIATIC ACID)	HCl	≤25	25	1	1		
DISTILLED WATER		100	25 60	1 1	1 1				60	2	1		
DRINKING WATER		100	25 60	1 1	1 1	HYDROCYANIC ACID (PRUSSIC ACID OR HYDROGEN CYANIDE)	HCN	deb	25	1	1		
ETHERS		all	25 60	3 3	1 1				60	1	1		
ETHYL - ACETATE (ACETIC ETHER) - ALCOHOL (ETHANOL) - CHLORIDE - ETHER	CH <sub>3</sub> CO <sub>2</sub> C <sub>2</sub> H <sub>5</sub>	100	25 60	3 3	1 3	HYDROFLUORIC ACID	HF	10	25	1	1		
	CH <sub>3</sub> CH <sub>2</sub> OH	nd	25 60	1 2	1 2				60	2	1		
	CH <sub>3</sub> CH <sub>2</sub> Cl	all	25 60	3 3	2	HYDROGEN	H <sub>2</sub>	all	25				
	CH <sub>3</sub> CH <sub>2</sub> OCH <sub>2</sub> CH <sub>3</sub>	all	25 60	3 3					60				
ETHYLENE - CHLOROHYDRIN - GLYCOL (ETHANEDIOL OR GLYCOL) FATTY ACIDS	CICH <sub>2</sub> CH <sub>2</sub> OH	100	25 60	3 3		HYDROGEN - PEROXIDE (BLEACH)	H <sub>2</sub> O <sub>2</sub>	30	25	1	1		
	HOCH <sub>2</sub> CH <sub>2</sub> OH	comm	25 60	1 1	1 3				60	1	1		
FERRIC - CHLORIDE  - NITRATE  - DEXTRINE (BRITISH GUM OR STARCH GUM) - SULFATE	FeCl <sub>3</sub>	10	25 60	1 2	1 1	HYDROSULPHITE	(H <sub>2</sub> NOH) <sub>2</sub> H <sub>2</sub> SO <sub>4</sub>	12	25	1	1		
		sat	25 60	1 1	1 1				60	1	1		
	Fe(NO <sub>3</sub> ) <sub>3</sub>	nd	25 60	1 1	1 1	HYDROXYLAMINE SULPHATE ILLUMINATING GAS		100	25	1	1		
	C <sub>6</sub> H <sub>12</sub> OCH <sub>2</sub> O	nd	25 60	1 2	1 1				60	1	1		
Fe(SO <sub>4</sub> ) <sub>3</sub>	nd	25 60	1 1	1 1	IODINE - DRY AND WET - TINCTURE	I <sub>2</sub>	3	25	2	2			
FeCl <sub>2</sub>	sat	25 60	1 1	1 1				60	3				
FERROUS - CHLORIDE - SULFATE	FeSO <sub>4</sub>	nd	25 60	1 1	1 1	ISOOCTANE	C <sub>8</sub> H <sub>18</sub>	100	25	1	2		
FERTILIZER		≤ 10	25 60	1 1	1 1				60	2	1		
FLUORINE GAS DRY	F <sub>2</sub>	100	25 60	2 3	2 3	ISO-OCTANE	(CH <sub>3</sub> ) <sub>3</sub> CCH <sub>2</sub> (CH <sub>3</sub> ) <sub>2</sub>						
FLUROSILICIC ACID	H <sub>2</sub> SiF <sub>6</sub>	32	25 60	1 1	1 1	ISOPROPYL -ETHER	(CH <sub>3</sub> ) <sub>2</sub> CHOCH(CH <sub>3</sub> ) <sub>2</sub>	100	25 60	2 3	2 3		
FORMALDEHYDE	HCOH	-	25 60	1 2	1 1	- ALCOHOL (ISOPROPANOL)	(CH <sub>3</sub> ) <sub>2</sub> CHOH	100	25 60	2			
FORMIC ACID	HCOOH	50	25 60	1 2	1 1	LACTIC ACID	CH <sub>3</sub> COHCOOH	≤28	25 60	1 2	1 1		
FRUIT PULP AND JUICE		comm	25 60	1 1	1 1	LANOLINE		nd	25 60	1 2	1 1		
		100	25 60	1 1	1 1	LEAD ACETATE	Pb(CH <sub>3</sub> COO) <sub>2</sub>	sat	25 60	1 1	-		
FUEL OIL		100	25 60	1 1	1 1	LINSEED OIL		comm	25 60	1 2	2		
FURFUROLE ALCOHOL	C <sub>5</sub> H <sub>3</sub> OCH <sub>2</sub> OH	nd	25 60	3 3	2 2	LUBRICATING OILS		comm	25 60	1 1	3		
GAS EXHAUST - ACID - WITH NITROUS - VAPOURS		all	25 60	1 1		MAGNESIUM - CARBONATE - CHLORIDE	MgCO <sub>3</sub>	all	25	1			
		traces	25 60	1 1	1 1				60	1			
GAS PHOSGENE	CICOCl	100	25 60	1 2	2	- HYDROXIDE	MgCl <sub>2</sub>	sat	25 60	1 1	1		
GELATINE		100	25 60	1 1	1 1	- NITRATE	Mg(OH) <sub>2</sub>	all	25 60	1 1			
GLUCOSE (DEXTRINE)	C <sub>6</sub> H <sub>12</sub> O <sub>6</sub>	all	25 60	1 2	1 1	- SULFATE	MgNO <sub>3</sub>	nd	25 60	1 1	1		
GLYCERINE AQ.SOL.(GLYCEROL)	HOCH <sub>2</sub> CHOHCH <sub>2</sub> OH	all	25 60	1 1	1 1	- MALIC ACID	COOHCH <sub>2</sub> COOH	nd	25 60	1 1	1		
GLYCOGLUE AQUEOUS		10	25 60	1 1	1 1	MALIC ACID (HYDROXYSUCCINIC ACID)	CH <sub>2</sub> CHOH(COOH) <sub>2</sub>	nd	25 60	1 1	1		
GLYCOLIC ACID	HOCH <sub>2</sub> COOH	37	25 60	1 1	1 1	MERCURIC HgCl <sub>2</sub> - CHLORIDE - CYANIDE		sat	25 60	1 1	1		
HEPTANE	C <sub>7</sub> H <sub>16</sub>	100	25 60	1 2	3	MERCUROUS NITRATE	HgCN <sub>2</sub>	all	25 60	1 1	1		
HEXANE	C <sub>6</sub> H <sub>14</sub>	100	25 60	1 2	2	MERCURY	Hg	100	25 60	1 2	1		
HYDROBROMIC ACID	HBr	≤10	25	1	1	METHYL - ACETATE - ALCOHOL (METHANOL OR WOODSPIRIT) - BROMIDE (BROMOMETHANE) - CHORIDE (CHLOROMETHANE) - ETHYLKETONE	CH <sub>3</sub> COOCH <sub>3</sub>	100	25	-	-		
			60	2	1				CH <sub>3</sub> OH	nd	25	1	1
			60	2	3				CH <sub>3</sub> Br	100	25	3	3
			60	2	2				CH <sub>3</sub> Cl	100	25	3	1
		48	25	1	1								
			60	2	1								
			60	2	1	METHYLAMINE	CH <sub>3</sub> NH <sub>2</sub>	32	25 60	2 3	1 2		

# 11. Chemical Resistance

	FORMULA	CONC %	TEMP (°C)	PVC	PE		FORMULA	CONC %	TEMP (°C)	PVC	PE
METHYLENE CHLORIDE (DICHLOROMETHANE)	CH <sub>2</sub> Cl <sub>2</sub>	100	25 60	3 3	3 3	- ANHYDRIDE		≤85 60	25 1	1 2	1 1
METHYL SULPHURIC ACID	CH <sub>3</sub> COOSO <sub>4</sub>	50 100	25 60	1 2	2 3		PHOSPHORUS TRICHLORIDE	P <sub>2</sub> O <sub>5</sub>	nd	25 60	1 2
MILK		100	25 60	1 1	1 1	PHOTOGRAPHIC - DEVELOPER - EMULSION		comm comm	25 60	1 1	1 1
MINERAL ACID/DOULOUS WATER		nd	25 60	1 1	1 1	PHTHALIC ACID	C <sub>6</sub> H <sub>4</sub> (CO <sub>2</sub> H) <sub>2</sub>	50	25 60	- 3	1 1
MOLASSES		comm	25 60	1 2	1 2	PICRIC ACID (2,4,6 TRINITROPENOL)	HOC <sub>6</sub> H <sub>2</sub> (NO <sub>2</sub> ) <sub>3</sub>	1 ≥1	25 60	1 3	1 1
NAPHTHA		100	25 60	2 3	2 3	POTASSIUM - BICHROMATE (POTASSIUM HYDROGENCARBONATE) - BORATE	K <sub>2</sub> Cr <sub>2</sub> O <sub>7</sub>	40	25 60	1 1	1 1
NAPHTALINE		100	25 60	1 2	1 1	- BROMATE	K <sub>3</sub> BO <sub>3</sub>	sat	25 60	1 2	1 1
NICKEL - CHLORIDE - NITRATE - SULFATE	NiCl <sub>3</sub> Ni(NO <sub>3</sub> ) <sub>2</sub> NiSO <sub>4</sub>	all nd dil sat	25 60 25 60	1 1 1 1	1 1 1 1	- BROMIDEKBr	KBrO <sub>3</sub>	nd	25 60	1 2	1 1
NITRIC ACID	HNO <sub>3</sub>	anhydrous 20 40 60 98	25 60 25 60 25 60	3 3 1 2 1 3 2 3 3	3 3 1 2 3 3 3 3	- CARBONATE (POTASH) - CHLORIDE (POTASSIUM MURIATE) - CHROMATE	K <sub>2</sub> CO <sub>3</sub> KCl K <sub>2</sub> CrO <sub>4</sub>	sat sat 40	25 60 25 60	1 1 1 1	1 1 1 1
NITROBENZENE	C <sub>6</sub> H <sub>5</sub> NO <sub>2</sub>	all	25 60	3 3	2 2	- CYANIDE	KCN	sat	25 60	1 1	1 1
OLEIC ACID	C <sub>18</sub> H <sub>34</sub> O <sub>2</sub>	comm	25 60	1 1	- 2	- FERROCYANIDE	K <sub>4</sub> Fe(CN) <sub>6</sub> H <sub>2</sub> O	100	25 60	1 1	1 1
OLEUM (FUMING SULPHURIC) ACID OR PYROSULPHURIC ACID) - VAPOURS	H <sub>2</sub> S <sub>2</sub> O <sub>7</sub>	nd low high	25 60 25 60	3 3 3 3	3 3	- FLUORIDE	KF	sat	25 60	1 1	1 1
OLIVE OIL		comm	25 60	2 3	3	- HYDROXIDE (CAUSTIC POTASH) - NITRATE KNO <sub>3</sub> (NITRE, SALTPETRE) - PERBORATE	KOH sat KBO <sub>3</sub>	≤60 25 all	25 60 25 60	1 2 1 1	1 1 1 1
OXALIC ACID	HO <sub>2</sub> CCO <sub>2</sub> H	10 sat	25 60 25 60	1 2 1 1	1 1 1 1	- PERBORATE	KBO <sub>3</sub>	all	25 60	1 1	1 1
OXYGEN	O <sub>2</sub>	all	25 60	1 1	1 2	- PERMANGANATE (PERMANGANATE OF POTASH) - PERSULFATE	KMnO <sub>4</sub> K <sub>2</sub> S <sub>2</sub> O <sub>8</sub>	10 nd	25 60 25 60	1 1 2 1	1 1 1 1
OZONE	O <sub>3</sub>	nd	25 60	1 2	2 3	- SULFATE	K <sub>2</sub> SO <sub>4</sub>	sat	25 60	1 2	1 1
PALMITIC ACID	CH <sub>3</sub> (CH <sub>2</sub> ) <sub>14</sub> COOH	10 70	25 60 25 60	1 1 1 1	- -	PROPANE - GAS - LIQUID	C <sub>3</sub> H <sub>8</sub>	100 100	25 60 25 60	1 1 1 2	1 1
PARAFFIN (ALKANE) - EMULSION - OIL (KEROSENE)		nd comm nd	25 60 25 60	2 2 1 1	2 2	PROPYL ALCOHOL (PROPANOL) PYRIDINE	C <sub>3</sub> H <sub>7</sub> OH CH(CHCH) <sub>2</sub> N	100 nd	25 60 25 60	1 2 3 2	1 1
PERCHLORIC ACID	HClO <sub>4</sub>	100 70	25 60 25 60	1 2 1 2	1 1 1 2	RAIN WATER		100	25 60	1 1	1 1
PETROL - REFINED - UNREFINED		100	25 60	1 1	1 1	SEA WATER		100	25 60	1 1	1 1
PHENOL - AQUEOUS SOLUTION (CARBOLIC ACID)	C <sub>6</sub> H <sub>5</sub> OH	1 ≤90	25 60	1 2	1 1	SILICIC ACID	H <sub>2</sub> SiO <sub>3</sub>	all	25 60	1 1	1 1
PHENYL HYDRAZINE - CHLORHYDRATE	C <sub>6</sub> H <sub>5</sub> NHNH <sub>2</sub> C <sub>6</sub> H <sub>5</sub> NHNH <sub>3</sub> Cl	all sat	25 60	3 3	2 2	SILICONE OIL		nd	25 60	1 3	1 2
PHOSPHORIC - ACID	H <sub>3</sub> PO <sub>4</sub>	≤25 ≤50	25 60 25 60	1 2 1 1	1 1 1 1	SILVER - CYANIDE - NITRATE - PLATING SOLUTION	AgCN AgNO <sub>3</sub>	all nd	25 60 25 60	1 1 1 2	1 1 1 1
						SOAP - AQUEOUS SOLUTION SODIC LYE		high ≤60	25 60 25 60	1 2 1 1	1 1 1 1
						SODIUM - ACETATE	CH <sub>3</sub> COONa	100	25 60	1 1	1 1

# 11. Chemical Resistance

	FORMULA	CONC %	TEMP (°C)	PVC	PE		FORMULA	CONC %	TEMP (°C)	PVC	PE
- BICARBONATE (SODIUM HYDROGEN CARBONATE)	NaHCO <sub>3</sub>	nd 60	25 1	1 1	1	- FUMING (OLEUM)		60	-3 25 60	2 2 3	
- BISULFITE	NaHSO <sub>3</sub>	100	25 60	1 1	1						
- BROMIDE	NaBr	sat	25 60	1 1		- NITRIC AQUEOUS SOLUTION	H <sub>2</sub> SO <sub>4</sub> +HNO <sub>3</sub> +H <sub>2</sub> O	48/49/3 50/50/0 10/20/70	25 25 25 60	1 2 3 1	3 3 2 2
- CARBONATE	Na <sub>2</sub> CO <sub>3</sub>	sat	25 60	1 1	1	TALLOW EMULSION		comm	25 60	1 1	1 2
- CHLORATE	NaClO <sub>3</sub>	nd	25 60	1 2	1	TANNIC ACID	C <sub>14</sub> H <sub>10</sub> O <sub>9</sub>	10	25 60	1 1	1 1
- CHLORIDE	NaCl	dil sat	25 60 25 60	1 2 1 1	1	TARTARIC ACID	HOOC(CHOH) <sub>2</sub> COOH	all	25 60	1 2	1 1
- CYANIDE	NaCN	all	25 60	1 1		TETRACHLORO-ETHANE	CHCl <sub>2</sub> CHCl <sub>2</sub>	nd	25 60	3 3	2 3
- FERROCYANIDE	Na <sub>4</sub> Fe(CN) <sub>6</sub>	sat	25 60	1 1	1	- ETHYLENE (PERCHLOROETHYLENE)	CCl <sub>2</sub> CCl <sub>2</sub>	nd	25 60	3 3	2 3
- FLUORIDE	NaF	all	25 60	1 1	1	TETRAETHYLLEAD	Pb(C <sub>2</sub> H <sub>5</sub> ) <sub>4</sub>	100	25 60	1 2	1 1
- HYDROXIDE	NaOH	60	25 60	1 1	1	TETRAHYDROFURAN	C <sub>4</sub> H <sub>8</sub> O	all	25 60	3 3	2 3
- HYPOCHLORITE	NaOCl	deb	25 60	1 2	1	THIONYL CHLORIDE	SOCl <sub>2</sub>	-	25 60	3 3	3 3
- HYPOSULFITE	Na <sub>2</sub> S <sub>2</sub> O <sub>3</sub>	nd	25 60	1 1		THIOPHENE	C <sub>4</sub> H <sub>4</sub> S	100	25 60	3 3	2 2
- NITRATE	NaNO <sub>3</sub>	nd	25 60	1 1	1	TOLUENE	C <sub>6</sub> H <sub>5</sub> CH <sub>3</sub>	100	25 60	3 3	2 3
- PERBORATE	NaBO <sub>3</sub> H <sub>2</sub> O	all	25 60	1 1		TRANSFORMER OIL		nd	25 60	1 2	1 2
- PHOSPHATE di	Na <sub>2</sub> HPO <sub>4</sub>	all	25 60	1 1		TRICHLORO-ACETIC ACID	CCl <sub>3</sub> COOH	≤50	25 60	1 3	1 2
- PHOSPHATE tri	Na <sub>3</sub> PO <sub>4</sub>	all	25 60	1 1	1	TRICHLOROETHYLENE	Cl <sub>2</sub> CCHCl	100	25 60	3 3	2 2
- SULPHATE	Na <sub>2</sub> SO <sub>4</sub>	dil sat	25 60 25 60	1 1 1 1		TRIETHANOLAMINE	N(CH <sub>2</sub> CH <sub>2</sub> OH) <sub>2</sub>	100	25 60	2 3	1 1
- SULFIDE	Na <sub>2</sub> S	dil sat	25 60 25 60	1 2 1 1	1	TURPENTINE		100	25 60	2 2	2 3
- SULFITE	NaSO <sub>3</sub>	sat	25 60	1 1		UREA AQUEOUS SOLUTION	CO(NH <sub>2</sub> ) <sub>2</sub>	≤ 10 33	25 60 25 60	1 1 1 2	1 1 1 1
STANNIC CHLORIDE	SnCl <sub>4</sub>	sat	25 60	1 1	1	URINE		nd	25 60	1 2	1 1
STANNOUS CHLORIDE	SnCl <sub>2</sub>	dil	25 60	1 1	1	URIC ACID	C <sub>5</sub> H <sub>4</sub> N <sub>4</sub> O <sub>3</sub>	10	25 60	1 2	1 1
STEARIC ACID	CH <sub>3</sub> (CH <sub>2</sub> ) <sub>16</sub> CO <sub>2</sub> H	100	25 60	1 2		VASELINE OIL		100	25 60	1 3	1 2
SUGAR SYRUP		high	25 60	1 2	1	VINYL ACETATE	CH <sub>3</sub> CO <sub>2</sub> CHCH <sub>2</sub>	100	25 60	3 3	
SULPHUR	S	100	25 60	1 2		WHISKEY		comm	25 60	1 1	
- DIOXIDE AQUEOUS	SO <sub>2</sub>	sat	25 60	1 2	1	WINES		comm	25 60	1 1	1
- DIOXIDE DRY		all	25 60	1 1	1	WINE VINEGAR		comm	25 60	1 2	1 1
- DIOXIDE LIQUID		100	25 60	2 3	2	ZINC - CHLORIDE	ZnCl <sub>2</sub>	dil sat	25 60 25 60	1 1 1 1	1 1 1 1
- TRIOXIDE	SO <sub>3</sub>	100	25 60	2 2	3	- CHROMATE	ZnCrO <sub>4</sub>	all	25 60	1 1	
SULPHURIC ACID	H <sub>2</sub> SO <sub>4</sub>	≤ 10 ≤75 ≤90 ≤96	25 60 25 60 25 60	1 1 1 2 2 2	1 1 1 2 2 2	- CYANIDE	Zn(CN) <sub>2</sub>	all	25 60	1	
						- NITRATE	Zn(NO <sub>3</sub> ) <sub>2</sub>	nd	25 60	1 1	
						- SULFATE	ZnSO <sub>4</sub>	dil sat	25 60 25 60	1 1 1 1	1 1 1 1



**DISCLAIMER**

This technical manual has been compiled by Marley New Zealand Limited ("The Company") to promote better understanding of the technical aspects of the Company's products to assist users in obtaining from them the best possible performance.

The technical manual is supplied subject to acknowledgment of the following conditions:

The technical manual is protected by Copyright and may not be copied or reproduced in any form or by any means in whole or in part without prior consent in writing by the Company.

Product specifications, usage data and advisory information may change from time to time with advances in research and field experience. The Company reserves the right to make such changes at any time without notice.

Correct usage of the Company's products involve engineering judgements which cannot be properly made without full knowledge of all the conditions pertaining to each specific installation. The Company expressly disclaims all and any liability to any person whether supplied with this publication or not in respect of anything and of the consequences of anything done or omitted to be done by any such person in reliance whether whole or partial upon the whole or any part of the contents of this publication.

No offer to trade, nor any conditions of trading, are expressed or implied by the issue or content of this manual.

Nothing herein shall override the Company's Conditions of Sale, which may be obtained from the Registered Office or any Sales Office of the Company.

This technical manual is and shall remain the property of the Company, and shall be surrendered on demand to the Company.

**AUCKLAND**

Mahia Road, Manurewa, Private Bag 802 Manurewa

Sales Department: Telephone 09 279 2777

Direct Fax 09 279 2778 Freefax 0800 652 621

Head Office: Telephone 09 279 2799 Fax 09 279

2798

**Sales Hotline:** 0800 222 922

**CHRISTCHURCH**

Shands Road, Hornby, PO Box 16233 Christchurch

**Sales Hotline:** 0800 222 922

For more information call free

**0800 MARLEY (0800 627 539)**